

Signalbehandlung & *kommunikationsinterfaces* *Produktkatalog*

PERFORMANCE
MADE
SMARTER



TEMPERATUR | EX-BARRIERER | KOMMUNIKATIONSINTERFACES | MULTIFUNKTIONEL | ISOLATION | DISPLAY

PR
electronics

Vores mål

er at skabe markedsledende standardløsninger med høj signalintegritet og brugervenlighed for vores kunder. Vi fokuserer på innovation inden for seks forretningsområder: temperatur, Ex-barrierer, kommunikationsinterfaces, multifunktionel, isolation og displays.

Vores produkter er fremragende hver for sig, men når vi kombinerer vores punkt til punkt-temperaturkonvertere, Ex-barrierer, backplanes, multifunktions-signalkonvertere og fremtidssikrede kommunikationsinterfaces, bliver vores løsninger enestående.

Vi ønsker at være

vores kunders pålidelige partner med de bedste og mest innovative signalbehandlingsløsninger inden for fabriksautomation og procesindustrien.

Vi tilbyder

vores kunder en lang række fordele via innovative løsninger og tæt samarbejde:

- Størst mulig signalintegritet fra procesmålepunkt til styresystem
- Maksimal opetid på basis af vores Install and Forget®-filosofi
- Nem og omkostningseffektiv procesindkøring og overvågning via intuitive kommunikationsinterfaces
- Standardenheder, der nemt kan programmeres, så de passer til den specifikke applikation
- Levering fra dag til dag

Vi har siden 1974 haft fokus på at videreudvikle vores kernekompetencer inden for innovativ højpræcisionsteknologi med lavt energiforbrug. Vores teknologi- og udviklingsafdeling er en integreret del af vores velfungerende produktion i hovedkvarteret i Danmark, hvilket betyder, at vi i dag er en af de førende virksomheder inden for signalbehandling.

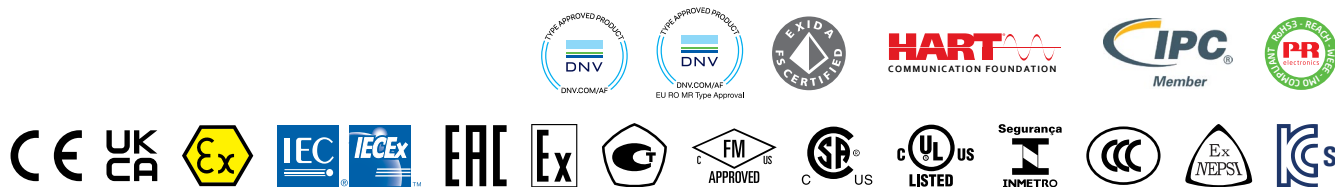

MULTIFUNKTIONELLE TRANSMITTERE

3114 - 4104 - 4114 - 4116 - 4131 - 4179 - 4184.....	4-5
5114A - 5115A - 5116A - 5131A - 9116A.....	6

FREKVENS / IMPULS

3202 - 3225 - 4222 - 4225.....	7
5202A - 5223A - 5225 - 9202A.....	8

ISOLATORER

3103 - 3104 - 3105 - 3108 - 3109.....	9
3117 - 3118 - 3185 - 3186.....	10
5104A - 5106A - 6185.....	11
9106A - 9107A - 9203A.....	12

TEMPERATURTRANSMITTERE

3101 - 3102 - 3111 - 3112 - 3113.....	13
3331 - 3333 - 3337.....	14
5331A - 5332A - 5333A - 5334A.....	15
5335A - 5337A - 5343A - 5437A.....	16
6331A - 6333A - 6334A - 6335A - 6337A.....	17
6437A - 7501 - 9113A.....	18

EX-TEMPERATURTRANSMITTERE

5331D - 5332D - 5333D - 5334B.....	19
5335D - 5337D - 5343B - 5437D.....	20
6331B - 6333B - 6334B - 6335D - 6337D.....	21
6437D - 7501.....	22

EX-BARRIERER

9106B - 9107B - 9113B - 9116B.....	23
9202B - 9203B.....	24
5104B - 5105B - 5106B.....	25
5114B - 5115B - 5116B - 5131B.....	26
5202B - 5203B - 5223B - 5420B.....	27

DISPLAYS

5531A - 5531B1 - 5714 - 5715 - 5725.....	28
--	----

EX-DISPLAYS

5531B - 5531B2.....	29
---------------------	----

SPÆNDINGSFORSYNINGER

3405 - 9410 - 9421.....	30
-------------------------	----

SPECIAL-MODULER

2224 - 2231 - 2261.....	31
-------------------------	----

BACKPLANE

.....	33
-------	----

SIGNALTYPER	33
--------------------------	----

PROGRAMMERINGSSEHEDER	34
------------------------------------	----

TILBEHØR	35-38
-----------------------	-------

POWER RAIL	39
3000 power rail - 9000 power rail	39

OMGIVELSESSPECIFIKATIONER	39
--	----

KABINETSPECIFIKATIONER	39
-------------------------------------	----

MULTIFUNKTIONELLE TRANSMITTERE



TYPE

3114

4104

4114

4116

4131

INDGANG:

RTD, TC, lineær modstand,
mV, mA, V, potentiometer

UDGANG:

mA, V, relæer

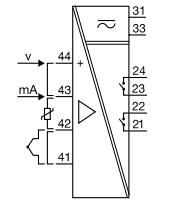
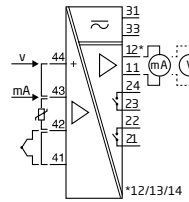
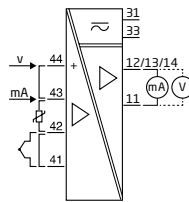
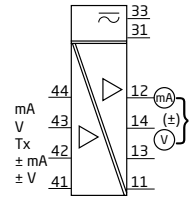
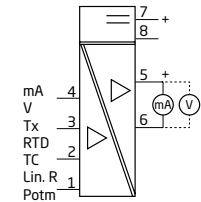

INDGANG:	3114	4104	4114	4116	4131
mA, måleområde / min. span	0...23 mA / 16 mA	-23...+23 mA	0...23 mA / 16 mA	0...23 mA / 16 mA	0...23 mA / 16 mA
V, måleområde / min. span	0...12 VDC / 0,8 V	-12...+12 VDC / 0,8 V	0...12 VDC / 0,8 V	0...12 VDC / 0,8 V	0...12 VDC / 0,8 V
RTD, måleområde / min. span	-200...+850°C / 25°C		-200...+850°C / -	-200...+850°C / -	-200...+850°C / -
Lin. R, måleområde / min. span	0...10000 Ω / -		0...10000 Ω / -	0...10000 Ω / -	0...10000 Ω / -
Potentiometer	10 Ω...100 kΩ		10 Ω...100 kΩ	10 Ω...100 kΩ	10 Ω...100 kΩ
Følerforbindelse, ledere	2 - 3 - 4		2 - 3 - 4	2 - 3 - 4	2 - 3 - 4
TC-typer	BEJKNRSTUW3W5Lr		BEJKNRSTUW3W5Lr	BEJKNRSTUW3W5Lr	BEJKNRSTUW3W5Lr
Koldt leddestedskompensering	Intern		Intern / ekstern	Intern / ekstern	Intern / ekstern
Referencespænding / 2-trådsforsyning	- / > 15 VDC	- / 16 VDC	- / 16 VDC	- / 16 VDC	- / 16 VDC
UDGANG:					
mA, signalområde / min. span	0...23 mA / 16 mA	-23...+23 mA / 16 mA	0...23 mA / 16 mA	0...23 mA / 16 mA	
Belastning (v. strømudgang)	≤ 600 Ω	≤ 800 Ω	≤ 800 Ω	≤ 800 Ω	
V, signalområde / min. span	0...10 VDC / 0,8 VDC	-10...+10 VDC / 0,8 VDC	0...10 VDC / 0,8 VDC	0...10 VDC / 0,8 VDC	
Belastning (v. spændingsudgang)	≥ 10 kΩ	≥ 500 kΩ			
Relæer				2 x SPST, AC: 500 VA	2 x SPST, AC: 500 VA
TEKNISKE SPECIFIKATIONER:					
Omgivelsestemperatur	-25...+70°C	-20...+60°C	-20...+60°C	-20...+60°C	-20...+60°C
Forsyningsspænding universel, AC / DC	- / 16,8...31,2 VDC	21,6...253 V / 19,2...300 V	21,6...253 V / 19,2...300 V	21,6...253 V / 19,2...300 V	21,6...253 V / 19,2...300 V
Max. forbrug	1,2 W	2,5 W	2,0 W	2,5 W	2,0 W
Isolationsspænding, test / drift	2,5 kVAC / 250 VAC	2,3 kVAC / 250 VAC	2,3 kVAC / 250 VAC	2,3 kVAC / 250 VAC	2,3 kVAC / 250 VAC
Reaktionstid	0,4 / 1,0 s	< 20 ms	< 400 ms	< 400 ms	< 400 ms
Signaldynamik, indgang / udgang	24 bit / 16 bit	20 bit / 18 bit	24 bit / 16 bit	24 bit / 16 bit	24 bit / -
Nøjagtighed	< ±0,1% af span	< ±0,05% af span	< ±0,1% af span	< ±0,1% af span	< ±0,1% af span
Temperaturkoefficient	< ±0,01% af span / °C	< ±0,01% af span / °C	< ±0,01% af span / °C	< ±0,01% af span / °C	< ±0,01% af span / °C
NAMUR	NE21, NE43	NE21	NE21, NE43	NE21, NE43	NE21, NE43
Kanaler	1	1	1	1	1
Programmering	Enheder i 4500-serien	Enheder i 4500-serien	Enheder i 4500-serien	Enheder i 4500-serien	Enheder i 4500-serien

GODKENDELSER:					
ATEX, Zone 2	✓				
IECEX, Zone 2	✓				
UKEX, Zone 2	✓				
FM, Zone 2 - DIV 2	✓	✓	✓	✓	✓
UL 61010 / 508	✓ / -	- / ✓	- / ✓	- / ✓	- / ✓
DNV / EU-RO marine	✓ / -	✓ / -	✓ / ✓	✓ / ✓	✓ / ✓
EAC	✓	✓	✓	✓	✓
SIL 2, Hardware Assessment			✓	✓	
CCC	✓				

APPLIKATIONSGUIDE:					
mA- / V- / temperaturindgang	✓ / ✓ / ✓	✓ / ✓ / -	✓ / ✓ / ✓	✓ / ✓ / ✓	✓ / ✓ / ✓
Bipolar mA- / V-indgang		✓ / ✓			
Lin. R / potentiometer-indgang	✓ / ✓		✓ / ✓	✓ / ✓	✓ / ✓
4...20 mA transmitter-indgang	✓	✓	✓	✓	✓
V-kurvefunktion		✓			
Bufferet spændingsudgang	✓				
Aktiv / passiv strømudgang	✓ / -	✓ / ✓	✓ / -	✓ / -	
Analog- / relæudgang	✓ / -	✓ / -	✓ / -	✓ / ✓	- / ✓
Kundedefineret følerlinearisering					
Kalibrering af processignal	✓	✓	✓	✓	✓
Forsyning via power rail	✓				



TYPE	4179	4184			
INDGANG: mV, mA, A, V, potentiometer	Universal AC/DC transmitter	Universel uni-/bipolar signaltransmitter			
UDGANG: mA, V					
INDGANG:					
mA, måleområde / min. span		±100 mA / 0,5 mA			
A, måleområde / min. span	0..5 AAC / 0,5 AAC				
V, måleområde / min. span	0..300 VAC / 0,5 VAC	±300 VDC / 25 mV			
RTD, måleområde / min. span					
Lin. R, måleområde / min. span					
Potentiometer		0..100 %			
Referencespænding / 2-trådsforsyning		2,5 V / 16 V			
3-trådsforsyning		> 18...< 28 V			
UDGANG:					
mA, signalområde / min. span	-23...+23 mA /	±23 mA / 4 mA			
Belastning (v. strømudgang)	≤ 800 Ω	≤ 1000 Ω			
V, signalområde / min. span	-10...+10 VDC / 0,8 VDC	-10...+10 VDC / 0,8 VDC			
Belastning (v. spændingsudgang)	≥ 500 kΩ	≥ 500 kΩ			
Bufferet spændingsudgang		± 23 V			
Belastning, min. (bufferet spændingsudgang)		> 2 kΩ			
TEKNISKE SPECIFIKATIONER:					
Omgivelsestemperatur	-20...+60°C	-20...+60°C			
Forsyningsspænding universel, AC / DC	21,6...253 V / 19,2...300 V	21,6...253 V / 19,2...300 V			
Max. forbrug	1,8 W	2,5 W			
Isolationsspænding, test / drift	2,3 kVAC / 250 VAC	2,3 kVAC / 250 VAC			
Reaktionstid	< 0,75 s	< 20 ms			
Signaldynamik, indgang / udgang	20 bit / 18 bit	24 bit / 18 bit			
Nøjagtighed	< ±0,3% af span	< ±0,05% af span			
Temperaturkoefficient	< ±0,01% af span / °C	< ±0,01% af span / °C			
NAMUR	NE21, NE43	NE21, NE43			
Kanaler	1	1			
Programmering	Enheder i 4500-serien	Enheder i 4500-serien			
GODKENDELSER:					
ATEX, Zone 2					
IECEX, Zone 2					
FM, Zone 2 - DIV 2					
UL 61010 / 508	- / ✓	- / ✓			
DNV					
EAC					
SIL 2, Hardware Assessment	✓	✓			
APPLIKATIONSGUIDE:					
mA- / V- / temperaturindgang	✓ / ✓ / -	✓ / ✓ / -			
Bipolar mA- / V-indgang		✓ / ✓			
Lin. R / potentiometer-indgang		- / ✓			
4...20 mA transmitter-indgang		✓			
V-kurvefunktion	✓	✓			
Bufferet spændingsudgang		✓			
Aktiv / passiv strømudgang	✓ / ✓	✓ / ✓			
Analog- / relæudgang	✓ / -	✓ / -			
Kundefineret følerlinearisering					
Kalibrering af processignal	✓	✓			
Forsyning via power rail					

MULTIFUNKTIONELLE TRANSMITTERE

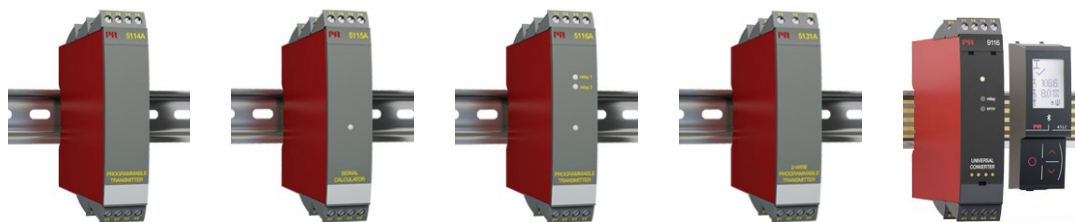

TYPE	5114A	5115A	5116A	5131A	9116A
------	-------	-------	-------	-------	-------

INDGANG:
RTD, TC, lineær modstand,
mV, mA, V, potentiometer

UDGANG:
mA, V, relæer

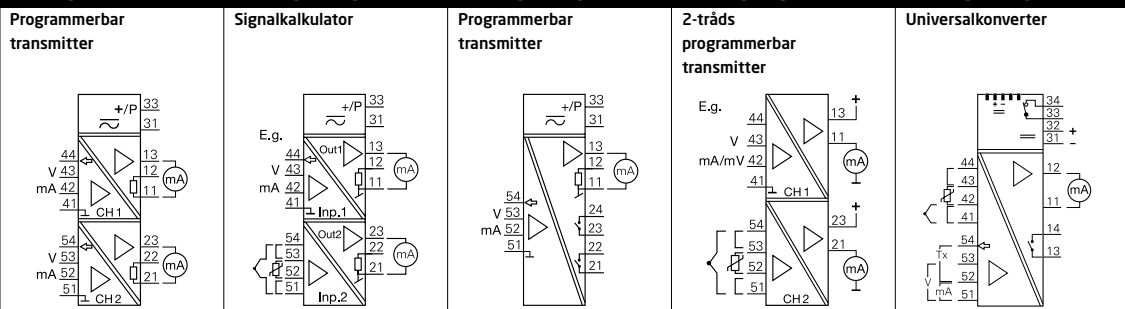

INDGANG:	5114A	5115A	5116A	5131A	9116A
mA, måleområde / min. span	0...100 mA / 4 mA	0...100 mA / 4 mA	0...100 mA / 4 mA	0...100 mA / 4 mA	0...23 mA / 16 mA
V, måleområde / min. span	0...250 VDC / 5 mV	0...250 VDC / 5 mV	0...250 VDC / 5 mV	0...250 VDC / 5 mV	0...12 VDC / 0,8 V
mV, måleområde / min. span	-150...+150 mV / 5 mV	-150...+150 mV / 5 mV	-2500...+2500 mV / 5 mV	-150...+150 mV / 5 mV	
RTD, måleområde / min. span	-200...+850°C / 25°C	-200...+850°C / 25°C	-200...+850°C / 25°C	-200...+850°C / 25°C	-200...+850°C / 25°C
Lin. R, måleområde / min. span	0...5000 Ω / 30 Ω	0...5000 Ω / 30 Ω	0...5000 Ω / 30 Ω	0...5000 Ω / 30 Ω	0...10000 Ω / -
Potentiometer	200 Ω...100 kΩ	200 Ω...100 kΩ	200 Ω...100 kΩ		10 Ω...10000 Ω
Følerforbindelse, ledere	2 - 3 - 4	2 - 3 - 4	2 - 3 - 4	2 - 3 - 4	2 - 3 - 4
TC-typer	BEJKNRSTUW3W5Lr	BEJKNRSTUW3W5Lr	BEJKNRSTUW3W5Lr	BEJKNRSTUW3W5Lr	BEJKNRSTUW3W5Lr
Max. nulpunktsforskydning	50% af valgt max. værdi	50% af valgt max. værdi	50% af valgt max. værdi	50% af valgt max. værdi	
Koldt loddestedskompensering	Intern / eksternt	Intern / eksternt	Intern / eksternt	Intern / eksternt	Intern / eksternt
Referencespænding / 2-trådsforsyning	2,5 VDC / > 17,1 VDC	2,5 VDC / > 17,1 VDC	2,5 VDC / > 16,5 VDC		- / > 16,5 VDC
UDGANG:					
mA, signalområde / min. span	0...23 mA / 10 mA	0...23 mA / 10 mA	0...23 mA / 10 mA	3,5...23 mA / 10 mA	0...23 mA / 16 mA
Belastning (v. strømudgang)	≤ 600 Ω	≤ 600 Ω	≤ 600 Ω	≤ (V _{forsyn.} -7,5) / 0,023 [Ω]	≤ 600 Ω
V, signalområde / min. span	0...10 VDC / 0,5 VDC	0...10 VDC / 0,5 VDC	0...10 VDC / 0,5 VDC		
Belastning (v. spændingsudgang)	≥ 500 kΩ	≥ 500 kΩ	≥ 500 kΩ		
Relæer			2 x SPST, AC: 500 VA		1 x SPST, AC: 500 VA
TEKNISKE SPECIFIKATIONER:					
Omgivelsestemperatur	-20...+60°C	-20...+60°C	-20...+60°C	-20...+60°C	-20...+60°C
Forsyningsspænding universel, AC / DC	21,6...253 V / 19,2...300 V	21,6...253 V / 19,2...300 V	21,6...253 V / 19,2...300 V	- / 7,5...35 VDC	- / 19,2...31,2 VDC
Max. forbrug, 1 / 2 kanaler	2,1 W / 2,8 W	2,1 W / 2,8 W	2,4 W / -	0,8 W	≤ 2,1 W
Isolationsspænding, test / drift	3,75 kVAC / 250 VAC	3,75 kVAC / 250 VAC	3,75 kVAC / 250 VAC	3,75 kVAC / 250 VAC	2,6 kVAC / 250 VAC
Reaktionstid	250 ms...60 s	250 ms...60 s	250 ms...60 s	1...60 s	0,4 / 1...60 s
Signaldynamik, indgang / udgang	22 bit / 16 bit	22 bit / 16 bit	22 bit / 16 bit	22 bit / 16 bit	24 bit / 16 bit
Nøjagtighed	< ±0,05% af span	< ±0,05% af span	< ±0,05% af span	< ±0,05% af span	< ±0,1% af span
Temperaturkoefficient	< ±0,01% af span / °C	< ±0,01% af span / °C	< ±0,01% af span / °C	< ±0,01% af span / °C	< ±0,01% af span / °C
NAMUR	NE21, NE43	NE21, NE43	NE21, NE43	NE21, NE43	NE21, NE43
Kanaler	1 eller 2	2	1	1 eller 2	1
Programmering	5909 + DIP-switch	5909 + DIP-switch	5909	5909 + DIP-switch	Enheder i 4500-serien

GODKENDELSER:	5114A	5115A	5116A	5131A	9116A
ATEX, Zone 2					✓
IECEX, Zone 2					✓
FM, Zone 2					✓
UL 61010 / 508 / 913			- / ✓ / -		✓ / - / ✓
DNV	✓	✓	✓		✓
EAC	✓	✓	✓	✓	✓
SIL 2 Full Assessment IEC 61508					✓
KCs					✓

APPLIKATIONSGUIDE:	5114A	5115A	5116A	5131A	9116A
mA - / V - / temperaturindgang	✓ / ✓ / ✓	✓ / ✓ / ✓	✓ / ✓ / ✓	✓ / ✓ / ✓	✓ / ✓ / ✓
Bipolar mV-indgang	✓	✓	✓	✓	✓
Lin. R / potentiometer-indgang	✓ / ✓	✓ / ✓	✓ / ✓	✓ / -	✓ / ✓
4...20 mA transmitter-indgang	✓	✓	✓	✓	✓
Dobbelt indgang - regnefunktioner		✓			
Bufferet spændingsudgang					
Aktiv / passiv strømudgang	✓ / ✓	✓ / ✓	✓ / ✓	✓	✓ / ✓
Analog- / relæudgang	✓ / -	✓ / -	✓ / ✓	✓ / -	✓ / ✓
Kundedefineret følerlinearisering	✓	✓	✓		
Kalibrering af processignal	✓	✓	✓	✓	✓
Forsyning via power rail					✓

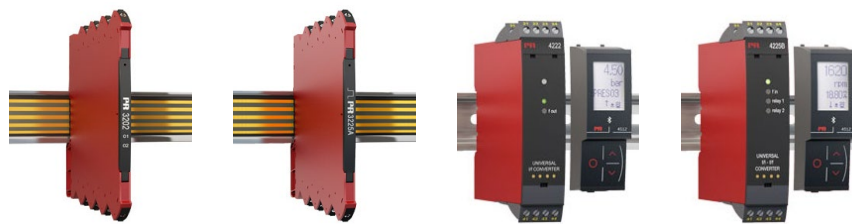

TYPE	3202	3225	4222	4225
------	------	------	------	------

INDGANG:
 Frekvens, impuls, V, mA,
 Pt100, TC, mV
UDGANG:
 mA, V, impuls, relæer

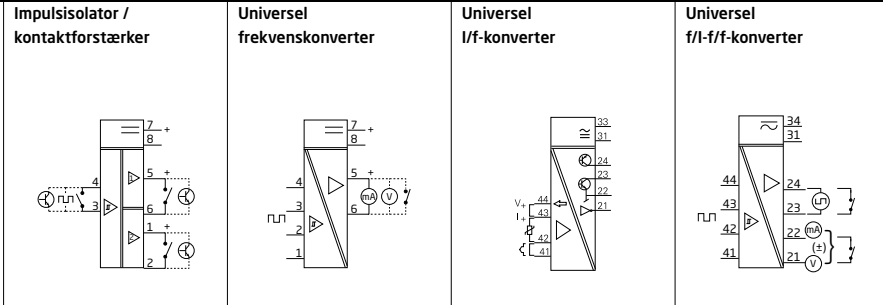

INDGANG:				
Følertype	NAMUR / NPN / kontakt	Alle standard følere \square		Alle standard følere \square
Hz, måleområde / min. span	0...5 kHz	0...100 kHz / 0,001 Hz		0...100 kHz / 0,001 Hz
Min. impulsbredde	> 100 μ s	4 μ s		4 μ s
mA, måleområde / min. span			0...23 mA / 16 mA	
V, måleområde / min. span			0...12 VDC	
RTD, måleområde / min. span			200...+850°C / -	
Lin. R, måleområde / potentiometer			0 Ω ...10 k Ω / 10 Ω ...100 k Ω	
Følerforbindelse, ledere			2 - 3 - 4	
TC-typer			BEJKNRSTUW3W5Lr	
UDGANG:				
mA, signalområde / min. span		0...23 mA / 16 mA		0...23 mA / 16 mA
V, signalområde / min. span		0...11,5 VDC / 0,8 VDC		0...11,5 VDC / 4 VDC
Hz, signalområde / min. span			0...25000 Hz / 0,001 Hz	0,001 Hz...100 kHz/0,001 Hz
Impulsudgang	NPN / relæ		NPN / PNP / TTL	NPN / PNP (4225C)
Relæer	2 x SPST, AC: 100 VA	1 (3225B)		1 (4225A) / 2 (4225B)
Max. udgangsrekvens	5 kHz		25 kHz	100 kHz
Følerforsyning	8,2 VDC	5...17 VDC	> 16 VDC	5...17 VDC
TEKNISKE SPECIFIKATIONER:				
Omgivelsestemperatur	-25...+70°C	-25...+70°C	-20...+60°C	-20...+60°C
Forsyningsspænding, AC / DC	- / 16,8...31,2 VDC	- / 16,8...31,2 VDC	21,6...253 V / 19,2...300 V	21,6...253V / 19,2...300V
Max. forbrug, 1 / 2 kanaler	1,2 W / -	1,2 W	2,5 W / -	2,6 W
Isolationsspænding, test / drift	2,5 kVAC / 250 VAC	2,5 kVAC / 250 VAC	2,3 kVAC / 250 VAC	2,3 kVAC / 250 VAC
Reaktionstid	< 20 ms	< 30 ms	< 1 s	< 30 ms
Signaldynamik, indgang / udgang		- / 18 bit	24 bit / -	- / 18 bit
Nøjagtighed		< 0,06% af span	< \pm 0,1% af span	< 0,06% af span
Temperaturkoefficient		0,006% / °C	< \pm 0,01% af span / °C	0,006% / °C
NAMUR	NE21, NE44	NE21, NE43	NE21	NE21, NE43
Kanaler	1	1	1	1
Programmering	DIP-switch	DIP-switch, PR 4590	Enheder i 4500-serien	Enheder i 4500-serien

GODKENDELSER:				
ATEX, Zone 2	✓	✓		
IECEx, Zone 2	✓	✓		
UKEX, Zone 2	✓	✓		
FM, Zone 2 - DIV 2	✓		✓	
UL 61010 / 508 / 913	✓ / - / -	✓ / - / -	- / ✓ / -	- / ✓ / -
DNV				
EAC			✓	
SIL 2, Hardware Assessment				✓
SIL 2 Full Assessment IEC 61508				
CCC	✓*	✓		

APPLIKATIONSGUIDE:				
Frekvens-til-analog konverter		✓		✓
Analog-til-frekvens konverter			✓	
Lin. R / potentiometer-indgang			✓ / ✓	
Samtidig f/I - f/f				
Impulskonvertering / -skalering				
Impulsisolator 1:1 / splitter	✓ / ✓			
Dobbelt indgang - regnefunktioner				
Digitaludgang	✓		✓	✓
Relæudgang	✓			✓
Kalibrering af processignal		✓	✓	✓
Forsyning via power rail	✓	✓		

ISOLATORER

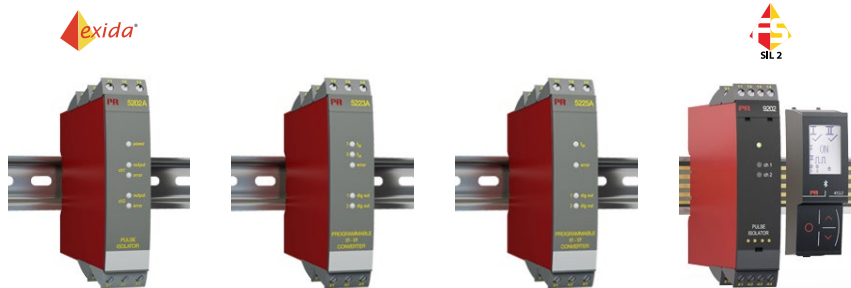

TYPE

5202A

5223A

5225A

9202A

INDGANG:
Frekvens, impuls

UDGANG:
mA, V, impuls, relæer

TYPE	5202A	5223A	5225A	9202A
	Impulsisolator	Programmerbar f/I - f/f konverter	Programmerbar f/I - f/f konverter	Impulsisolator

INDGANG:	5202A	5223A	5225A	9202A
Følertype	NAMUR / kontakt	Alle standard følere \square	Alle standard følere \square	NAMUR / kontakt
Hz, måleområde / min. span	0...5 kHz	0...20 kHz / 0,001 Hz	0...20 kHz / 0,001 Hz	0...5 kHz
Min. impulsbredde	> 100 μ s	25 μ s	25 μ s	> 100 μ s
UDGANG:				
mA, signalområde / min. span		0...23 mA / 5 mA	0...23 mA / 5 mA	
V, signalområde / min. span		0...10 VDC / 0,25 VDC	0...10 VDC / 0,25 VDC	
Hz, signalområde / min. span	0...5 kHz / -			0...5 kHz
Impulsudgang	NPN / relæ	NPN / PNP eller relæer	NPN / PNP eller relæer	NPN / relæ
Relæer	2 x SPDT, AC: 100 VA	2 x SPST, AC: 500 VA	2 x SPST, AC: 500 VA	1 x SPST, AC: 500 VA
Max. udgangsfrekvens		1000 Hz	1000 Hz	
Følereforsyning		5...17 VDC	5...17 VDC	
TEKNISKE SPECIFIKATIONER:				
Omgivelsestemperatur	-20...+60°C	-20...+60°C	-20...+60°C	-20...+60°C
Forsyningsspænding, AC / DC	21,6...253 V / 19,2...300 V	21,6...253 V / 19,2...300 V	- / 19,2...28,8 VDC	- / 19,2...31,2 VDC
Max. forbrug, 1 / 2 kanaler	- / 1,5 W eller 1,8 W*	3 W	3,5 W	\leq 1,1...1,3 W / \leq 1,5...1,9 W
Isolationsspænding, test / drift	3,75 kVAC / 250 VAC	3,75 kVAC / 250 VAC	3,75 kVAC / 250 VAC	2,6 kVAC / 250 VAC
Reaktionstid		60 ms...1000 s	60 ms...1000 s	200 ms
Signaldynamik, indgang / udgang		- / 16 bit	- / 16 bit	
Nøjagtighed		< \pm 0,1% af span	< \pm 0,1% af span	
Temperaturkoefficient		< \pm 0,01% af span / °C	< \pm 0,01% af span / °C	
NAMUR	NE21			NE21
Kanaler	2	1	1	1 eller 2
Programmering	DIP-switch	5909 + DIP-switch	5909 + DIP-switch	Enheder i 4500-serien

GODKENDELSER:				
ATEX, Zone 2				✓
IECEX, Zone 2				✓
FM, Zone 2 - DIV 2				✓
UL 61010 / 508 / 913	- / ✓ / -			✓ / - / ✓
DNV				✓
EAC	✓	✓	✓	✓
SIL 2, Hardware Assessment	✓			
SIL 2 Full Assessment IEC 61508				✓
CCC				✓
KCs				✓

APPLIKATIONSGUIDE:				
Frekvens-til-analog konverter		✓	✓	
Analog-til-frekvens konverter				
Lin. R / potentiometer-indgang				
Samtidig f/I - f/f			✓	
Impulskonvertering / -skalering		✓	✓	
Impulsisolator 1:1				✓
Dobbelt indgang - regnefunktioner	✓	✓		
Digitaludgang		✓	✓	✓
Relæudgang	✓	✓	✓	✓
Kalibrering af processignal	✓	✓	✓	
Forsyning via power rail				✓

ISLATORER

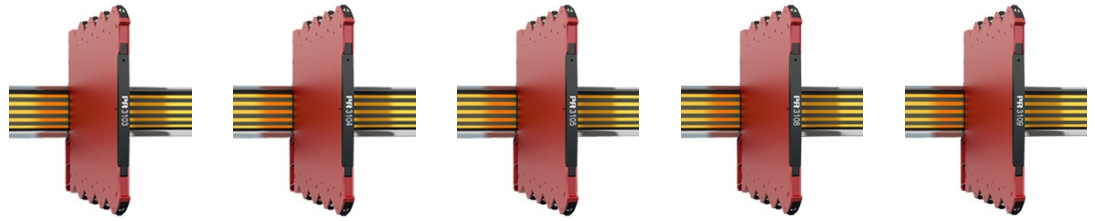

TYPE	3103	3104	3105	3108	3109
	Isolator / repeater	Isolator/konverter	Isolator/konverter	Isolator/repeater/splitter	Isolator/konverter/splitter
INDGANG: mA, V, potentiometer					
UDGANG: mA, V					
INDGANG:					
mA, måleområde / min. span	0...23 mA / 1:1	0...23 mA / 16 mA	0...23 mA / 16 mA	0...23 mA / 1:1	0...23 mA / 16 mA
V, måleområde / min. span		0...10,25 VDC / 4 VDC	0...10,25 VDC / 4 VDC		0...10,25 VDC / 4 VDC
Referencespænding / 2-trådsforsyning		- / > 17 V			- / > 17 V
UDGANG:					
mA, signalområde / min. span	0...23 mA / 1:1	0...23 mA / 16 mA	0...23 mA / 16 mA	0...23 mA / 1:1	0...23 mA / 16 mA
Belastning (v. strømudgang)	≤ 600 Ω	≤ 600 Ω	≤ 600 Ω	≤ 300 Ω per kanal	≤ 300 Ω per kanal
V, signalområde / min. span		0...10 VDC / 4 VDC	0...10 VDC / 4 VDC		0...10 VDC / 4 VDC
Belastning (v. spændingsudgang)		≥ 10 kΩ	≥ 10 kΩ		≥ 10 kΩ
TEKNISKE SPECIFIKATIONER:					
Omgivelsestemperatur	-25...+70°C	-25...+70°C	0...+70°C	-25...+70°C	-25...+70°C
Forsyningsspænding, AC / DC	- / 16,8...31,2 VDC	- / 16,8...31,2 VDC	- / 16,8...31,2 VDC	- / 16,8...31,2 VDC	- / 16,8...31,2 VDC
Max. forbrug*	0,65 W	1,2 W	0,8 W	0,75 W	1,2 W
Isolationsspænding, test / drift	2,5 kVAC / 250 VAC	2,5 kVAC / 250 VAC	2,5 kVAC / 250 VAC	2,5 kVAC / 250 VAC	2,5 kVAC / 250 VAC
Reaktionstid	< 7 ms	< 7 ms	< 7 ms	< 7 ms	< 7 ms
Signaldynamik, indgang / udgang	Analog signaloverførsel	Analog signaloverførsel	Analog signaloverførsel	Analog signaloverførsel	Analog signaloverførsel
Nøjagtighed	< ±0,05% af span	< ±0,05% af span	< ±0,2% af span	< ±0,05% af span	< ±0,05% af span
Temperaturkoefficient	< ±0,01% af span / °C	< ±0,01% af span / °C	< ±0,015% af span / °C	< ±0,01% af span / °C	< ±0,01% af span / °C
NAMUR	NE21	NE21	NE21	NE21	NE21
Kanaler	1	1	1	1	1
Programmering	Nej	DIP-switch	DIP-switch	Nej	DIP-switch
GODKENDELSER:					
ATEX, Zone 2	✓	✓		✓	✓
IECEx, Zone 2	✓	✓		✓	✓
UKEX, Zone 2	✓	✓		✓	✓
FM, Zone 2 - DIV 2	✓	✓		✓	✓
UL 61010 / 508	✓ / -	✓ / -	✓ / -	✓ / -	✓ / -
DNV	✓	✓	✓	✓	✓
EAC	✓	✓	✓	✓	✓
CCC	✓	✓		✓	✓
APPLIKATIONSGUIDE:					
Signal-repeater	✓			✓	
Signal-konverter		✓	✓		✓
Signal-splitter				✓	✓
mA / V bipolar indgang					
4...20 mA transmitter-indgang		✓			✓
Bufferet spændingsudgang		✓	✓		✓
mA- / V-udgang	✓ / -	✓ / ✓	✓ / ✓	✓ / -	✓ / ✓
Aktiv / passiv mA-udgang	✓ / -	✓ / -	✓ / -	✓ / -	✓ / -
Montering i Zone 2 / DIV 2	✓	✓	✓	✓	✓
Forsyning via power rail	✓	✓	✓	✓	✓

* = @ 24 VDC

Af span = Af det aktuelt valgte område

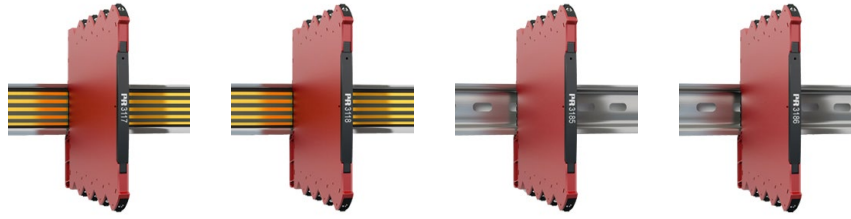

TYPE	3117	3118	3185	3186	
INDGANG: mA, V, potentiometer					
UDGANG: mA, V					
INDGANG:					
mA, måleområde / min. span	-23...+23 mA	-23...+23 mA	0...23 mA / 1:1	3,5...23 mA / 1:1	
V, måleområde / min. span	±5 og ±10 VDC	±5 og ±10 VDC			
Referencespænding / 2-trådsforsyning				- / V _{loop} -2,5 VDC	
UDGANG:					
mA, signalområde / min. span	0...23 mA / 16 mA	0...23 mA / 16 mA	0...23 mA / 1:1	3,5...23 mA / 1:1	
Belastning (v. strømudgang)	≤ 600 Ω	≤ 300 Ω per kanal	≤ 600 Ω		
V, signalområde / min. span	0...10 VDC / 4 VDC	0...10 VDC / 4 VDC			
Belastning (v. spændingsudgang)	≥ 10 kΩ	≥ 10 kΩ			
TEKNISKE SPECIFIKATIONER:					
Omgivelsestemperatur	-25...+70°C	-25...+70°C	-25...+70°C	-25...+70°C	
Forsyningsspænding, AC / DC	- / 16,8...31,2 VDC	- / 16,8...31,2 VDC	≤ 1,25 V + (0,015 x V _{udg.})	- / 6...35 VDC	
Max. forbrug	*0,8 W	*0,8 W	30 mW per kanal	50 mW per kanal	
Isolationsspænding, test / drift	2,5 kVAC / 250 VAC	2,5 kVAC / 250 VAC	2,5 kVAC / 250 VAC	2,5 kVAC / 250 VAC	
Reaktionstid	< 7 ms	< 7 ms	< 5 ms	< 5 ms	
Signaldynamik, indgang / udgang	Analog signaloverførsel	Analog signaloverførsel	Analog signaloverførsel	Analog signaloverførsel	
Nøjagtighed	< ±0,05% af span	< ±0,05% af span	< ±0,1% af span	< ±0,05% af span	
Temperaturkoefficient	< ±0,01% af span / °C	< ±0,01% af span / °C	< ±0,01% af span / °C	< ±0,01% af span / °C	
NAMUR	NE21	NE21	NE21	NE21	
Kanaler	1	1	1 eller 2	1 eller 2	
Programmering	DIP-switch	DIP-switch	Nej	Nej	
GODKENDELSER:					
ATEX, Zone 2	✓	✓	✓	✓	
IECEX, Zone 2	✓	✓	✓	✓	
UKEX, Zone 2	✓	✓	✓	✓	
FM, Zone 2 - DIV 2	✓	✓	✓	✓	
UL 61010 / 508	✓ / -	✓ / -	✓ / -	✓ / -	
DNV	✓	✓	✓	✓	
EAC	✓	✓	✓	✓	
CCC	✓	✓	✓	✓	
APPLIKATIONSGUIDE:					
Signal-repeater			✓	✓	
Signal-konverter	✓	✓			
Signal-splitter		✓			
mA / V bipolar indgang	✓	✓ / ✓			
4...20 mA transmitter-indgang				✓	
Bufferet spændingsudgang	✓	✓			
Aktivt / passivt indgangssignal			✓ / -	✓ / ✓	
mA - / V-udgang	✓ / ✓	✓ / ✓	✓ / -	✓ / -	
Aktiv / passiv mA-udgang	✓ / -	✓ / -	✓ / -	- / ✓	
Montering i Zone 2 / DIV 2	✓	✓	✓	✓	
Forsyning via power rail	✓	✓			

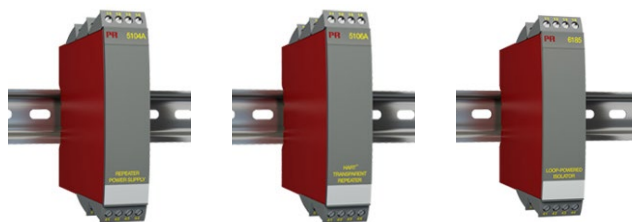

TYPE	5104A	5106A	6185		
	Repeater/ spændingsforsyning	HART-transparent repeater	Loop-forsynet isolator		
INDGANG: mA, mV, V, HART-transparent					
UDGANG: mA, V, HART-transparent					
INDGANG:					
mA, måleområde / min. span	0...23 mA / 16 mA	3,5...23 mA / 1:1	0...23 mA / 1:1		
V, måleområde / min. span	0...10 VDC / 8 VDC				
Max. nulpunktsforskydning	20% af valgt max. værdi				
Referencespænding / 2-trådsforsyning	- / > 17,1 VDC	- / > 17 VDC			
UDGANG:					
mA, signalområde / min. span	0...23 mA / 16 mA	3,5...23 mA / 1:1	0...23 mA / 1:1		
Belastning (v. strømudgang)	≤ 600 Ω	≤ 600 Ω	≤ 600 Ω		
V, signalområde / min. span	0...10 VDC / 0,8 VDC				
Belastning (v. spændingsudgang)	≥ 500 kΩ				
Max. nulpunktsforskydning	20% af valgt max. værdi				
TEKNISKE SPECIFIKATIONER:					
Omgivelsestemperatur	-20...+60°C	-20...+60°C	-20...+60°C		
Forsyningsspænding, AC / DC	21,6...253 V / 19,2...300 V	21,6...253 V / 19,2...300 V	- / ≤ 1,8 VDC		
Max. forbrug, 1 / 2 kanaler	2,0 W / 2,8 W	2,0 W / 2,8 W	40 mW per kanal		
Isolationsspænding, test / drift	3,75 kVAC / 250 VAC	3,75 kVAC / 250 VAC	2 kVAC / -		
Reaktionstid	< 25 ms	< 25 ms	< 4 ms		
Signaldynamik, indgang / udgang	Analog signaloverførsel	Analog signaloverførsel	Analog signaloverførsel		
Nøjagtighed	< ±0,1% af span	< ±0,1% af span	< ±0,1% af span		
Temperaturkoefficient	< ±0,01% af span / °C	< ±0,01% af span / °C	< ±0,01% af span / °C		
NAMUR	NE21	NE21			
Kanaler	1 eller 2	1 eller 2	1, 2 eller 4		
Programmering	DIP-switch	Nej	Nej		
GODKENDELSER:					
ATEX, Zone 2					
IECEX, Zone 2					
FM, Zone 2 - DIV 2					
UL 61010 / 508	- / ✓	- / ✓			
DNV	✓				
EAC	✓	✓	✓		
APPLIKATIONSGUIDE:					
Signal-repeater		✓	✓		
Signal-konverter	✓				
Signal-splitter					
mA / V bipolar indgang					
4...20 mA transmitter-indgang	✓	✓			
Bufferet spændingsudgang					
Aktivt / passivt indgangssignal				✓ / -	
mA- / V-udgang	✓ / ✓	✓ / -		✓ / -	
Aktiv / passiv mA-udgang	✓ / ✓	✓ / ✓		✓ / -	
Montering i Zone 2 / DIV 2					
Forsyning via power rail					

ISOLATORER



TYPE

9106A

9107A

9203A

INDGANG:
mA, HART-kommunikation

UDGANG:
mA,
HART-kommunikation

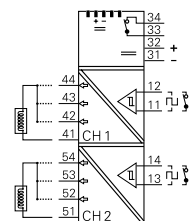
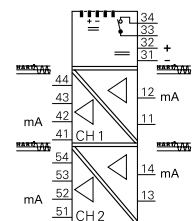
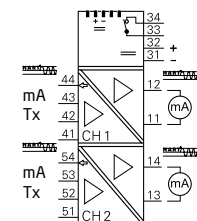

INDGANG:	9106A	9107A	9203A		
mA, måleområde / min. span	3,5...23 mA / 16 mA	3,5...23 mA / 16 mA			
V, måleområde / min. span					
Max. nulpunktsforskydning					
Referencespænding / 2-trådsforsyning	- / > 16 VDC				
Følertype				NPN / PNP / kontakt	
UDGANG:					
mA, signalområde / min. span	3,5...23 mA / 16 mA	3,5...23 mA / 16 mA			
Impulsudgang				Ventiler mm.	
TEKNISKE SPECIFIKATIONER:					
Omgivelsestemperatur	-20...+60°C	-20...+60°C	-20...+60°C		
Forsyningsspænding, AC / DC	- / 19,2...31,2 VDC	19,2...31,2 VDC	19,2...31,2 VDC		
Max. forbrug, 1 / 2 kanaler	≤ 1,1 W / ≤ 1,9 W	≤ 1,0 W / ≤ 1,8 W	≤ 1,9...2,5 W / ≤ 3,1 W		
Isolationsspænding, test / drift	2,6 kVAC / 250 VAC	2,6 kVAC / 250 VAC	2,6 kVAC / 250 VAC		
Reaktionstid	< 5 ms	< 5 ms	< 10 ms		
Signaldynamik, indgang	Analog signaloverførsel	Analog signaloverførsel			
Nøjagtighed	≤ ±16 µA	< ±16 µA			
Temperaturkoefficient	≤ ±1,6 µA / °C	< ±0,01% af span / °C			
NAMUR	NE21	NE21	NE21		
Kanaler	1 eller 2	1 eller 2	1 eller 2		
Programmering	Enheder i 4500-serien	Enheder i 4500-serien	Enheder i 4500-serien		

GODKENDELSER:	9106A	9107A	9203A		
ATEX, Zone 2	✓	✓	✓		
IECEX, Zone 2	✓	✓	✓		
FM, Zone 2 - DIV 2	✓	✓	✓		
UL 61010 / 913	✓ / ✓	✓ / ✓	✓ / ✓		
DNV	✓	✓	✓		
EAC	✓	✓	✓		
SIL 2/3 Full Assessment IEC 61508	✓	✓	✓		
CCC	✓	✓	✓		
KCs	✓	✓	✓		

APPLIKATIONSGUIDE:	9106A	9107A	9203A		
Signal-repeater	✓				
Signal-driver		✓			
Signal-splitter	✓				
Ventil- / alarmdriver			✓		
mA indgang	✓	✓			
4...20 mA transmitter-indgang	✓				
Aktiv / passiv mA-udgang	✓ / ✓	✓ / -			
HART-signal transparent	✓	✓			
Montering i Zone 2 / DIV 2	✓	✓	✓		
Forsyning via power rail	✓	✓	✓		

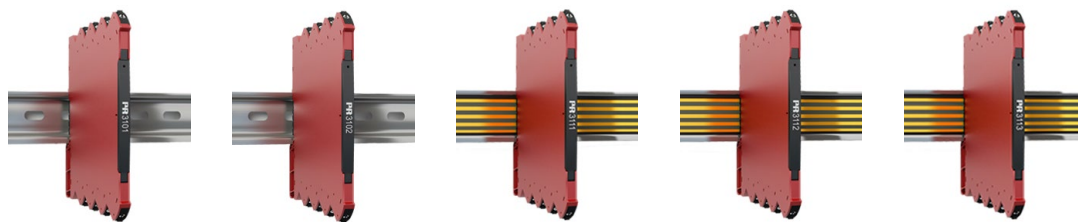

TYPE	3101	3102	3111	3112	3113
INDGANG: RTD, lineær modstand, TC, mV, mA, potentiometer	TC-konverter	Pt100-konverter	Isoleret TC-konverter	Isoleret Pt100-konverter	Isoleret HART 7 temperaturkonverter
UDGANG: mA, HART-kommunikation					
INDGANG:					
RTD, måleområde / min. span		-200...+850°C / 10°C		-200...+850°C / 10°C	-200...+850°C / 10°C
Lin. R, måleområde / min. span					
Følerforbindelse, ledere		2 - 3 - 4		2 - 3 - 4	2 - 3 - 4
TC-typer	J & K		J & K		J & K
Max. nulpunktsforskydning					
Koldt loddestedskompensering	Intern		Intern / ekstern		Intern / ekstern
UDGANG:					
mA, signalområde / min. span	0...23 mA / 16 mA	0...23 mA / 16 mA	0...23 mA / 16 mA	0...23 mA / 16 mA	0...23 mA / 16 mA
Belastning (v. strømudgang)	≤ 600 Ω	≤ 600 Ω	≤ 600 Ω	≤ 600 Ω	≤ 600 Ω
V, signalområde / min. span	0...10 VDC / 4 VDC	0...10 VDC / 4 VDC	0...10 VDC / 4 VDC	0...10 VDC / 4 VDC	
Belastning (v. spændingsudgang)	≥ 10 kΩ	≥ 10 kΩ	≥ 10 kΩ	≥ 10 kΩ	
TEKNISKE SPECIFIKATIONER:					
Omgivelsestemperatur	-25...70°C	-25...70°C	-25...70°C	-25...70°C	-25...70°C
Forsyningsspænding, DC	16,8...31,2 VDC	16,8...31,2 VDC	16,8...31,2 VDC	16,8...31,2 VDC	16,8...31,2 VDC
Max. forbrug*	0,52 W	0,52 W	0,7 W	0,7 W	0,7 W
Isolationsspænding, test / drift			2,5 kVAC / 250 VAC	2,5 kVAC / 250 VAC	2,5 kVAC / 250 VAC
Reaktionstid	< 30 ms	< 30 ms	< 30 ms	< 30 ms	< 60 ms
Signaldynamik, indgang / udgang	23 bit / 18 bit	23 bit / 18 bit	23 bit / 18 bit	23 bit / 18 bit	23 bit / 18 bit
Nøjagtighed	< ±0,1% af span	< ±0,1% af span	< ±0,05% af span	< ±0,05% af span	< ±0,05% af span
Temperaturkoefficient	< ±0,01% af span / °C	< ±0,01% af span / °C	< ±0,01% af span / °C	< ±0,01% af span / °C	< ±0,01% af span / °C
NAMUR	NE21, NE43	NE21, NE43	NE21, NE43	NE21, NE43	NE21, NE43
Kanaler	1	1	1	1	1
Programmering	DIP-switch	DIP-switch	DIP-switch	DIP-switch	DIP-switch / HART
GODKENDELSER:					
ATEX, Zone 2	✓	✓	✓	✓	✓
IECEX, Zone 2	✓	✓	✓	✓	✓
UKEX, Zone 2	✓	✓	✓	✓	✓
FM, Zone 2 - DIV 2	✓	✓	✓	✓	✓
UL 61010 / 508	✓ / -	✓ / -	✓ / -	✓ / -	✓ / -
DNV	✓	✓	✓	✓	✓
EAC	✓	✓	✓	✓	✓
APPLIKATIONSGUIDE:					
RTD- / TC- / mV-indgang	- / ✓ / -	✓ / - / -	- / ✓ / -	✓ / - / -	✓ / ✓ / -
mA- / V-udgang	✓ / ✓	✓ / ✓	✓ / ✓	✓ / ✓	✓ / -
Loop-forsyning					
Galvanisk isoleret			✓	✓	✓
HART-protokol					✓
Montering i Zone 2 / DIV 2	✓ / ✓	✓ / ✓	✓ / ✓	✓ / ✓	✓ / ✓
Kalibrering af processignal					✓
Forsyning via power rail			✓	✓	✓

* = @ 24 VDC

Af span = Af det aktuelt valgte område

TEMPERATURTRANSMITTERE



TYPE

3331

3333

3337

INDGANG:
RTD, lineær modstand,
TC, mV

UDGANG:
mA, V,
HART-kommunikation

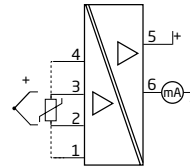
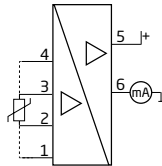
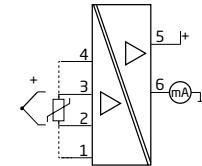

INDGANG:

RTD, måleområde / min. span	-200...+850°C / 10°C	-200...+850°C / 10°C	-200...+850°C / 10°C
Lin. R, måleområde / min. span			
Følerforbindelse, ledere	2 - 3 - 4	2 - 3 - 4	2 - 3 - 4
TC-typer	J & K		J & K
Max. nulpunktsforskydning			
Koldt loddestedskompensering	Intern / ekstern		Intern / ekstern

UDGANG:

mA, signalområde / min. span	3,5...23 mA / 16 mA	3,5...23 mA / 16 mA	3,5...23 mA / 16 mA
Belastning (v. strømudgang)	$\leq (V_{\text{forsyn.}} - 5,5) / 0,023 [\Omega]$	$\leq (V_{\text{forsyn.}} - 3,3) / 0,023 [\Omega]$	$\leq (V_{\text{forsyn.}} - 6,2) / 0,023 [\Omega]$

TEKNISKE SPECIFIKATIONER:

Omgivelsestemperatur	-25...70°C	-25...70°C	-25...70°C
Forsyningsspænding, DC	5,5...35 VDC	3,3...35 VDC	6,2...35 VDC
Max. forbrug	0,8 W	0,8 W	0,8 W
Isolationsspænding, test / drift	2,5 kVAC / 250 VAC		2,5 kVAC / 250 VAC
Reaktionstid	< 30 ms	< 30 ms	< 60 ms
Signaldynamik, indgang / udgang	23 bit / 18 bit	23 bit / 18 bit	23 bit / 18 bit
Nøjagtighed	< ±0,05% af span	< ±0,1% af span	< ±0,05% af span
Temperaturkoefficient	< ±0,01% af span / °C	< ±0,01% af span / °C	< ±0,01% af span / °C
NAMUR	NE21, NE43	NE21, NE43	NE21, NE43
Kanaler	1	1	1
Programmering	DIP-switch	DIP-switch	DIP-switch / HART

GODKENDELSER:

ATEX, Zone 2	✓	✓	✓
IECEX, Zone 2	✓	✓	✓
UKEX, Zone 2	✓	✓	✓
FM, Zone 2 - DIV 2	✓	✓	✓
UL 61010 / 508	✓ / -	✓ / -	✓ / -
DNV	✓	✓	✓
EAC	✓	✓	✓

APPLIKATIONSGUIDE:

RTD- / TC- / mV-indgang	✓ / ✓ / -	✓ / - / -	✓ / ✓ / -
mA- / V-udgang	✓ / -	✓ / -	✓ / -
Loop-forsynet	✓	✓	✓
Galvanisk isoleret	✓		✓
HART-protokol			✓
Montering i Zone 2 / DIV 2	✓ / ✓	✓ / ✓	✓ / ✓
Kalibrering af processignal			✓



TYPE	5331A	5332A	5333A	5334A
INDGANG: RTD, lineær modstand, TC, mV, potentiometer	2-tråds programmerbar transmitter	2-tråds programmerbar RTD-transmitter	2-tråds programmerbar transmitter	2-tråds programmerbar transmitter
UDGANG: mA				
INDGANG:				
mV, måleområde / min. span	-12...800 mV / 5 mV			-12...150 mV / 5 mV
RTD, måleområde / min. span	-200...+850°C / 25°C	-200...+850°C / 25°C	-200...+850°C / 25°C	
Lin. R, måleområde / min. span	0...5000 Ω / 30 Ω	0...5000 Ω / 30 Ω	0...10 kΩ / 30 Ω	
Potentiometer				
Følerforbindelse, ledere	2 - 3 - 4	2 - 3 - 4	2 - 3	
TC-typer	BEJKNRSTUW3W5Lr			BEJKNRSTUW3W5Lr
Max. nulpunktsforskydning	50% af valgt max. værdi	50% af valgt max. værdi	50% af valgt max. værdi	50% af valgt max. værdi
Koldt loddestedskompensering	Intern / ekstern			Intern
UDGANG:				
mA, signalområde / min. span	3,5...23 mA / 16 mA	3,5...23 mA / 16 mA	3,5...23 mA / 16 mA	3,5...23 mA / 16 mA
TEKNISKE SPECIFIKATIONER:				
Omgivelsestemperatur	-40...+85°C	-40...+85°C	-40...+85°C	-40...+85°C
Forsyningsspænding, DC	7,2...35 VDC	7,2...35 VDC	8...35 VDC	7,2...35 VDC
Max. forbrug	0,8 W	0,8 W	0,8 W	0,8 W
Isolationsspænding, test / drift	1500 VAC / 50 V			1500 VAC / 50 V
Reaktionstid	1...60 s	1...60 s	0,33...60 s	1...60 s
Signaldynamik, indgang / udgang	20 bit / 16 bit	20 bit / 16 bit	19 bit / 16 bit	18 bit / 16 bit
Nøjagtighed	< ±0,05% af span	< ±0,05% af span	< ±0,1% af span	< ±0,05% af span
Temperaturkoefficient	< ±0,01% af span / °C	< ±0,01% af span / °C	< ±0,01% af span / °C	< ±0,01% af span / °C
NAMUR	NE21, NE43	NE21, NE43	NE43	NE21, NE43
Kanaler	1	1	1	1
Programmering	5909	5909	5909	5909
GODKENDELSER:				
ATEX, Zone 2	✓	✓	✓	✓
IECEx, Zone 2	✓	✓	✓	✓
CSA, Zone 2 - DIV 2	✓	✓	✓	
FM, Zone 2 - DIV 2				
INMETRO	✓		✓	✓
NEPSI				
DNV	✓		✓	✓
EAC	✓		✓	✓
SIL Hardware Assessment				
APPLIKATIONSGUIDE:				
RTD- / TC- / mV-indgang	✓ / ✓ / ✓	✓ / - / -	✓ / - / -	- / ✓ / ✓
Lin. R / potentiometer-indgang	✓ / -	✓ / -	✓ / -	
Dobbelt indgang (4 terminaler)				
Kundefineret følerlinearisering	✓	✓	✓	✓
mA-udgang	✓	✓	✓	✓
Loop-forsynet	✓	✓	✓	✓
Galvanisk isoleret	✓			✓
HART-protokol				
Montering i Zone 2 / DIV 2	✓ / -	✓ / -	✓ / -	✓ / -
Kalibrering af processignal	✓	✓	✓	✓

TEMPERATURTRANSMITTERE



TYPE	5335A	5337A	5343A	5437A
INDGANG: RTD, lineær modstand, TC, mV, potentiometer	2-tråds transmitter med HART 5 protokol	2-tråds transmitter med HART 7 protokol	2-tråds niveautransmitter	2-tråds HART 7 temperaturtransmitter
UDGANG: mA, HART-kommunikation				
INDGANG:				
mV, måleområde	-800...+800 mV	-800...+800 mV		± 800 mV, -0,1...+1,7 V
mV, min. span	2,5 mV	2,5 mV		2,5 mV
RTD, måleområde / min. span	-200...+850°C / 10°C	-200...+850°C / 10°C		-200...+850°C / 10°C
Lin. R, måleområde / min. span	0...7000 Ω / 25 Ω	0...7000 Ω / 25 Ω	0...100 kΩ / 1 kΩ	0...100 kΩ / 25 Ω
Potentiometer				10 Ω...100 kΩ / 10%
Følerforbindelse, ledere	2 - 3 - 4	2 - 3 - 4		2 - 3 - 4
TC-typer	BEJLNRSTUW3W5	BEJLNRSTUW3W5		BEJLNRSTUW3W5Lr
Max. nulpunktsforskydning	50% af valgt max. værdi	50% af valgt max. værdi	50% af valgt max. værdi	Intern / ekstern
Koldt loddestedskompensering	Intern / ekstern	Intern / ekstern	Intern / ekstern	Intern / ekstern
UDGANG:				
mA, signalområde / min. span	3,5...23 mA / 16 mA	3,5...23 mA / 16 mA	3,5...23 mA / 16 mA	3,5...23 mA / 16 mA
TEKNISKE SPECIFIKATIONER:				
Omgivelsestemperatur	-40...+85°C	-40...+85°C	-40...+85°C	-50...+85°C
Forsyningsspænding, DC	8...35 VDC	8...35 VDC	8...35 VDC	7,5...48 VDC
Max. forbrug	0,8 W	0,8 W	0,8 W	< 850 mW
Isolationsspænding, test / drift	1500 VAC / 50 V	1500 VAC / 50 V		2,5 kVAC / 55 VAC
Reaktionstid	1...60 s	1...60 s	0,33...60 s	70 ms
Signaldynamik, indgang / udgang	22 bit / 16 bit	22 bit / 16 bit	19 bit / 16 bit	24 bit / 18 bit
Nøjagtighed	< ±0,05% af span	< ±0,05% af span	< ±0,1% af span	≤ ±0,05% af span
Temperaturkoefficient	< ±0,005% af span / °C	< ±0,005% af span / °C	< ±0,01% af span / °C	< ±0,005% af span / °C
NAMUR	NE21, NE43, NE89	NE21, NE43, NE89	NE43	NE 21/43/44/89/95/107/130
Kanaler	1	1	1	1 eller 2*
Programmering	5909/HART 5	5909/HART 7/HART 5	5909	5909 / HART 7 / HART 5
GODKENDELSER:				
ATEX, Zone 2	✓	✓	✓	✓
IECEX, Zone 2	✓	✓	✓	✓
CSA, Zone 2 - DIV 2	✓	✓		✓
FM, Zone 2 - DIV 2				✓
INMETRO	✓	✓	✓	✓
NEPSI				✓
DNV / EU-RO marine	✓ / -	✓ / -	✓ / -	- / ✓
EAC	✓	✓	✓	✓
SIL Hardware Assessment	✓	✓		
SIL 2/3 Full Assessment IEC 61508				✓ / ✓
APPLIKATIONSGUIDE:				
RTD- / TC- / mV-indgang	✓ / ✓ / ✓	✓ / ✓ / ✓		✓ / ✓ / ✓
Lin. R / potentiometer-indgang	✓ / -	✓ / -	✓ / ✓	✓ / ✓
Dobbelt indgang (4 terminaler)	✓	✓		
Ægte dobbelt indgang (7 terminaler)				✓
Kundefineret følerlinearisering	✓	✓	✓	✓
mA-udgang	✓	✓	✓	✓
Loop-forsynet	✓	✓	✓	✓
Galvanisk isoleret	✓	✓		✓
HART-protokol	✓	✓		✓
Montering i Zone 2 / DIV 2	✓ / -	✓ / -	✓ / -	✓ / ✓
Kalibrering af processignal	✓	✓	✓	✓



TEMPERATURTRANSMITTERE



TYPE	6331A	6333A	6334A	6335A	6337A
INDGANG: RTD, lineær modstand, TC, mV, potentiometer	2-tråds programmerbar transmitter	2-tråds programmerbar transmitter	2-tråds programmerbar transmitter	2-tråds HART transmitter	2-tråds HART transmitter
UDGANG: mA, HART-kommunikation					
INDGANG:					
mV, måleområde / min. span	-12...800 mV / 5 mV		-12...+150 mV / 5 mV	-800...+800 mV / 2,5 mV	-800...+800 mV / 2,5 mV
RTD, måleområde / min. span	-200...+850°C / 25°C	-200...+850°C / 25°C		-200...+850°C / 10°C	-200...+850°C / 10°C
Lin. R, måleområde / min. span	0...5000 Ω / 30 Ω	0...10 kΩ / 30 Ω		0...7000 Ω / 25 Ω	0...7000 Ω / 25 Ω
Potentiometer					
Følerforbindelse, ledere	2 - 3 - 4	2 - 3		2 - 3 - 4	2 - 3 - 4
TC-typer	BEJLKNRSTUW3W5Lr		BEJLKNRSTUW3W5Lr	BEJLKNRSTUW3W5	BEJLKNRSTUW3W5
Max. nulpunktsforskydning	50% af valgt max. værdi	50% af valgt max. værdi	50% af valgt max. værdi	50% af valgt max. værdi	50% af valgt max. værdi
Koldt loddestedskompensering	Intern / ekstern		Intern	Intern / ekstern	Intern / ekstern
UDGANG:					
mA, signalområde / min. span	3,5...23 mA / 16 mA	3,5...23 mA / 16 mA	3,5...23 mA / 16 mA	3,5...23 mA / 16 mA	3,5...23 mA / 16 mA
TEKNISKE SPECIFIKATIONER:					
Omgivelsestemperatur	-40...+85°C	-40...+85°C	-40...+85°C	-40...+85°C	-40...+85°C
Forsyningsspænding, DC	7,2...35 VDC	8...35 VDC	7,2...35 VDC	8...35 VDC	8...35 VDC
Max. forbrug, 1 / 2 kanaler	0,8 W / 1,6 W	0,8 W / 1,6 W	0,8 W / 1,6 W	0,8 W / 1,6 W	0,8 W / 1,6 W
Isolationsspænding, test / drift	1500 VAC / 50 V		1500 VAC / 50 V	1500 VAC / 50 V	1500 VAC / 50 V
Reaktionstid	1...60 s	0,33...60 s	1...60 s	1...60 s	1...60 s
Signaldynamik, indgang / udgang	20 bit / 16 bit	19 bit / 16 bit	18 bit / 16 bit	22 bit / 16 bit	22 bit / 16 bit
Nøjagtighed	< ±0,05% af span	< ±0,1% af span	< ±0,05% af span	< ±0,05% af span	< ±0,05% af span
Temperaturkoefficient	< ±0,01% af span / °C	< ±0,01% af span / °C	< ±0,01% af span / °C	< ±0,005% af span / °C	< ±0,005% af span / °C
NAMUR	NE21, NE43	NE43	NE21, NE43	NE21, NE43, NE89	NE21, NE43, NE89
Kanaler	1 eller 2	1 eller 2	1 eller 2	1 eller 2	1 eller 2
Programmering	5909	5909	5909	5909/HART 5	5909/HART 7/HART 5
GODKENDELSER:					
ATEX, Zone 2	✓	✓	✓	✓	✓
IECEx, Zone 2	✓	✓	✓	✓	✓
CSA, Zone 2 - DIV 2	✓	✓		✓	✓
FM, Zone 2 - DIV 2					
UL 61010 / 508					
DNV					
EAC	✓	✓	✓	✓	✓
SIL Hardware Assessment				✓	✓
SIL 2 Full Assessment IEC 61508					
APPLIKATIONSGUIDE:					
RTD- / TC- / mV-indgang	✓ / ✓ / ✓	✓ / - / -	- / ✓ / ✓	✓ / ✓ / ✓	✓ / ✓ / ✓
Lin. R / potentiometer-indgang	✓ / -	✓ / -		✓ / -	✓ / -
Dobbelt indgang (4 terminaler)				✓	✓
Kundefineret følerlinearisering	✓	✓	✓	✓	✓
mA-udgang	✓	✓	✓	✓	✓
Loop-forsynet	✓	✓	✓	✓	✓
Galvanisk isoleret	✓		✓	✓	✓
HART-protokol				✓	✓
Montering i Zone 2 / DIV 2	✓ / -	✓ / -	✓ / -	✓ / -	✓ / -
Kalibrering af processignal	✓	✓	✓	✓	✓

TEMPERATURTRANSMITTERE



TYPE	6437A	7501	9113A		
INDGANG: RTD, lineær modstand, TC, mV, mA, potentiometer	2-tråds HART 7 temperaturtransmitter	Feltmonteret HART-temperaturtransmitter	Temperatur-/mA-konverter		
UDGANG: mA, HART-kommunikation					
INDGANG: mA, måleområde / min. span			0...23 mA / 16 mA		
mV, måleområde	± 800 mV, -0,1...+1,7 V	-800...+800 mV			
mV, min. span	2,5 mV	2,5 mV			
RTD, måleområde / min. span	-200...+850°C / 10°C	-200...+850°C / 10°C	-200...+850°C / 25°C		
Lin. R, måleområde / min. span	0...100 kΩ / 25 Ω	0...7000 Ω / 25 Ω			
Potentiometer	0...100 kΩ / 10%				
Følerforbindelse, ledere	2 - 3 - 4	2 - 3 - 4	2 - 3 - 4		
TC-typer	BEJKNRSTUW3W5Lr	BEJKNRSTUW3W5	BEJKNRSTUW3W5Lr		
Koldt loddestedskompensering	Intern / eksternt	Intern / eksternt	Intern / eksternt		
UDGANG: mA, signalområde / min. span	3,5...23 mA / 16 mA	3,5...23 mA / 16 mA	0...23 mA / 16 mA		
TEKNISKE SPECIFIKATIONER: Omgivelsestemperatur	-50...+85°C	-40...+85°C	-20...+60°C		
Forsyningsspænding, DC	7,5...48 VDC	10 / 12...35 VDC	19,2...31,2 VDC		
Max. forbrug, 1 / 2 kanaler	< 850 mW / -		≤ 0,8 W / ≤ 1,4 W		
Isolationsspænding, test / drift	2,5 kVAC / 55 VAC	1500 VAC / 50 VAC	2,6 kVAC / 250 VAC		
Reaktionstid	70 ms	22 bit / 16 bit	0,4 / 1...60 s		
Signaldynamik, indgang / udgang	24 bit / 18 bit	1...60 s	24 bit / 16 bit		
Nøjagtighed	≤ ±0,05% af span	≤ ±0,05% af span	< ±0,1% af span		
Temperaturkoefficient	< ±0,005% af span / °C	< ±0,005% af span / °C	< ±0,01% af span / °C		
NAMUR	NE21 / 43 / 44 / 89 / 107	NE21, NE43	NE21, NE43		
Kanaler	1 eller 2*	1	1 eller 2		
Programmering	5909 / HART 7 / HART 5	LOI / HART	Enheder i 4500-serien		
GODKENDELSER: ATEX, Zone 2 / IECEx, Zone 2	✓ / ✓	✓ / ✓	✓ / ✓		
CSA, Zone 2 - DIV 2	✓				
FM, Zone 2 - DIV 2	✓				
INMETRO / NEPSI	✓ / ✓				
UL 61010 / 913			✓ / ✓		
DNV / EU-RO marine	- / ✓	- / ✓	✓ / -		
EAC	✓	✓	✓		
SIL Hardware Assessment		✓			
SIL 2/3 Full Assessment IEC 61508	✓ / ✓		✓ / -		
KCs			✓		
APPLIKATIONSGUIDE: RTD- / TC- / mV-indgang	✓ / ✓ / ✓	✓ / ✓ / ✓	✓ / ✓ / -		
Lin. R / potentiometer-indgang	✓ / ✓	✓ / -			
Dobbelt indgang (4 terminaler)		✓			
Ægte dobbelt indgang (8 terminaler)	✓				
Kundedefineret følerlinearisering	✓	✓			
mA-udgang	✓	✓	✓		
Loop-forsynet	✓	✓			
Galvanisk isoleret	✓	✓	✓		
HART-protokol	✓	✓			
Kalibrering af processignal	✓	✓	✓		
Forsyning via power rail			✓		



TYPE	5331D	5332D	5333D	5334B
INDGANG: RTD, lineær modstand, TC, mV, potentiometer	2-tråds programmerbar transmitter	2-tråds programmerbar RTD-transmitter	2-tråds programmerbar transmitter	2-tråds programmerbar transmitter
UDGANG: mA				
INDGANG:				
mV, måleområde / min. span	-12...800 mV / 5 mV	-200...+850°C / 25°C	-200...+850°C / 25°C	-200...+850°C / 25°C
RTD, måleområde / min. span	-200...+850°C / 25°C	-200...+850°C / 25°C	-200...+850°C / 25°C	-200...+850°C / 25°C
Lin. R, måleområde / min. span	0...5000 Ω / 30 Ω	0...5000 Ω / 30 Ω	0...10 kΩ / 30 Ω	0...10 kΩ / 30 Ω
Potentiometer				
Følerforbindelse, ledere	2 - 3 - 4	2 - 3 - 4	2 - 3	2 - 3 - 4
TC-typer	BEJLKNRSTUW3W5Lr			BEJLKNRSTUW3W5Lr
Max. nulpunktsforskydning				
Koldt loddestedskompensering	Intern / ekstern	Intern / ekstern		Intern
UDGANG:				
mA, signalområde / min. span	3,5...23 mA / 16 mA	3,5...23 mA / 16 mA	3,5...23 mA / 16 mA	3,5...23 mA / 16 mA
TEKNISKE SPECIFIKATIONER:				
Omgivelsestemperatur	-40...+85°C	-40...+85°C	-40...+85°C	-40...+85°C
Forsyningsspænding, DC	7,2...30 VDC	7,2...30 VDC	8...30 VDC	7,2...30 VDC
Max. forbrug	0,7 W	0,7 W	0,7 W	0,7 W
Isolationsspænding, test / drift	1500 VAC / 50 V	1500 VAC / 50 V	1500 VAC / 50 V	1500 VAC / 50 V
Reaktionstid	1...60 s	1...60 s	0,33...60 s	1...60 s
Signaldynamik, indgang / udgang	20 bit / 16 bit	20 bit / 16 bit	19 bit / 16 bit	18 bit / 16 bit
Nøjagtighed	< ±0,05% af span	< ±0,05% af span	< ±0,1% af span	< ±0,05% af span
Temperaturkoefficient	< ±0,01% af span / °C	< ±0,01% af span / °C	< ±0,01% af span / °C	< ±0,01% af span / °C
NAMUR	NE21, NE43	NE21, NE43	NE43	NE21, NE43
Kanaler	1	1	1	1
Programmering	5909	5909	5909	5909
GODKENDELSER:				
ATEX	✓	✓	✓	✓
IECEx	✓	✓	✓	✓
FM	✓	✓	✓	✓
CSA	✓	✓	✓	✓
INMETRO	✓	✓	✓	✓
DNV	✓	✓	✓	✓
EAC Ex	✓	✓	✓	✓
NEPSI	✓	✓	✓	✓
SIL Hardware Assessment	✓	✓	✓	✓
APPLIKATIONSGUIDE:				
RTD- / TC- / mV-indgang	✓ / ✓ / ✓	✓ / - / -	✓ / - / -	- / ✓ / ✓
Lin. R / potentiometer-indgang	✓ / -	✓ / -	✓ / -	
Dobbelt indgang (4 terminaler)				
Kundedefineret følerlinearisering	✓	✓	✓	✓
mA-udgang	✓	✓	✓	✓
Loop-forsynet	✓	✓	✓	✓
Galvanisk isoleret	✓	✓	✓	✓
HART-protokol				
Kalibrering af processignal	✓	✓	✓	✓

EX-TEMPERATURTRANSMITTERE



TYPE	5335D	5337D	5343B	5437D
INDGANG: RTD, lineær modstand, TC, mV, potentiometer	2-tråds transmitter med HART 5 protokol	2-tråds transmitter med HART 7 protokol	2-tråds niveautransmitter	2-tråds HART 7 temperaturtransmitter
UDGANG: mA, HART-kommunikation				
INDGANG:				
mV, måleområde	-800...+800 mV	-800...+800 mV		± 800 mV, -0,1...+1,7 V
mV, min. span	2,5 mV	2,5 mV		2,5 mV
RTD, måleområde / min. span	-200...+850°C / 10°C	-200...+850°C / 10°C		-200...+850°C / 10°C
Lin. R, måleområde / min. span	0...7000 Ω / 25 Ω	0...7000 Ω / 25 Ω	0...100 kΩ / 1 kΩ	0...100 kΩ / 25 Ω
Potentiometer			1 kΩ...100 kΩ	10 Ω...100 kΩ / 10%
Følerforbindelse, ledere	2 - 3 - 4	2 - 3 - 4		2 - 3 - 4
TC-typer	BEJLNRSTUW3W5	BEJLNRSTUW3W5		BEJLNRSTUW3W5Lr
Max. nulpunktsforskydning			50% af valgt max. værdi	
Koldt loddestedskompensering	Intern / ekstern	Intern / ekstern		Intern / ekstern
UDGANG:				
mA, signalområde / min. span	3,5...23 mA / 16 mA	3,5...23 mA / 16 mA	3,5...23 mA / 16 mA	3,5...23 mA / 16 mA
TEKNISKE SPECIFIKATIONER:				
Omgivelsestemperatur	-40...+85°C	-40...+85°C	-40...+85°C	-50...+85°C
Forsyningsspænding, DC	8...30 VDC	8...30 VDC	8...30 VDC	7,5...30 VDC
Max. forbrug	0,7 W	0,7 W	0,7 W	< 850 mW
Isolationsspænding, test / drift	1500 VAC / 50 V	1500 VAC / 50 V		2,5 kVAC / 42 VAC
Reaktionstid	1...60 s	1...60 s	0,33...60 s	70 ms
Signaldynamik, indgang / udgang	22 bit / 16 bit	22 bit / 16 bit	19 bit / 16 bit	24 bit / 18 bit
Nøjagtighed	< ±0,05% af span	< ±0,05% af span	< ±0,1% af span	≤ ±0,05% af span
Temperaturkoefficient	< ±0,005% af span / °C	< ±0,005% af span / °C	< ±0,01% af span / °C	< ±0,005% af span / °C
NAMUR	NE21, NE43, NE89	NE21, NE43, NE89	NE43	NE21/43/44/89/95/107/130
Kanaler	1	1	1	1 eller 2*
Programmering	5909/HART 5	5909/HART 7/HART 5	5909	5909 / HART 7 / HART 5
GODKENDELSER:				
ATEX	✓	✓	✓	✓
IECEX	✓	✓	✓	✓
FM	✓	✓	✓	✓
CSA	✓	✓	✓	✓
INMETRO	✓	✓	✓	✓
DNV / EU-RO marine	✓ / -	✓ / -	✓ / -	- / ✓
EAC Ex			✓	✓
NEPSI				✓
SIL Hardware Assessment	✓	✓		
SIL 2/3 Full Assessment IEC 61508				✓ / ✓
APPLIKATIONSGUIDE:				
RTD- / TC- / mV-indgang	✓ / ✓ / ✓	✓ / ✓ / ✓		✓ / ✓ / ✓
Lin. R / potentiometer-indgang	✓ / -	✓ / -	✓ / ✓	✓ / ✓
Dobbelt indgang (4 terminaler)	✓	✓		
Ægte dobbelt indgang (7 terminaler)			✓	✓
Kundefineret følerlinearisering	✓	✓	✓	✓
mA-udgang	✓	✓	✓	✓
Loop-forsynet	✓	✓		✓
Galvanisk isoleret	✓	✓		✓
HART-protokol	✓	✓	✓	✓
Kalibrering af processignal	✓	✓		✓



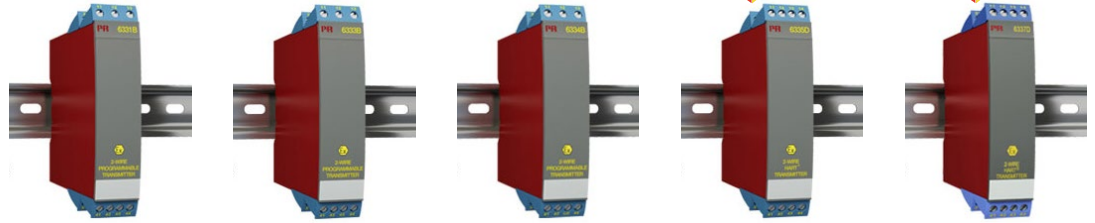

TYPE	6331B	6333B	6334B	6335D	6337D
INDGANG: RTD, lineær modstand, TC, mV, potentiometer	2-tråds programmerbar transmitter	2-tråds programmerbar transmitter	2-tråds programmerbar transmitter	2-tråds HART 5 transmitter	2-tråds HART 7 transmitter
UDGANG: mA, HART-kommunikation					
INDGANG:					
mV, måleområde / min. span	-12...800 mV / 5 mV		-12...+150 mV / 5 mV	-800...+800 mV / 2,5 mV	-800...+800 mV / 2,5 mV
RTD, måleområde / min. span	-200...+850°C / 25°C	-200...+850°C / 25°C		-200...+850°C / 10°C	-200...+850°C / 10°C
Lin. R, måleområde / min. span	0...5000 Ω / 30 Ω	0...10 kΩ / 30 Ω		0...7000 Ω / 25 Ω	0...7000 Ω / 25 Ω
Potentiometer					
Følerforbindelse, ledere	2 - 3 - 4	2 - 3		2 - 3 - 4	2 - 3 - 4
TC-typer	BEJKNRSTUW3W5Lr		BEJKNRSTUW3W5Lr	BEJKNRSTUW3W5	BEJKNRSTUW3W5
Max. nulpunktsforskydning	50% af valgt max. værdi	50% af valgt max. værdi	50% af valgt max. værdi	50% af valgt max. værdi	50% af valgt max. værdi
Koldt loddestedskompensering	Intern / ekstern		Intern	Intern / ekstern	Intern / ekstern
UDGANG:					
mA, signalområde / min. span	3,5...23 mA / 16 mA	3,5...23 mA / 16 mA	3,5...23 mA / 16 mA	3,5...23 mA / 16 mA	3,5...23 mA / 16 mA
TEKNISKE SPECIFIKATIONER:					
Omgivelsestemperatur	-40...+85°C	-40...+85°C	-40...+85°C	-40...+85°C	-40...+85°C
Forsyningsspænding, DC	7,2...30 VDC	8...30 VDC	7,2...30 VDC	8...30 VDC	8...30 VDC
Max. forbrug, 1 / 2 kanaler	0,7 W / 1,4 W	0,7 W / 1,4 W	0,7 W / 1,4 W	0,7 W / 1,4 W	0,7 W / 1,4 W
Isolationsspænding, test / drift	1500 VAC / 50 V		1500 VAC / 50 V	1500 VAC / 50 V	1500 VAC / 50 V
Reaktionstid	1...60 s	0,33...60 s	1...60 s	1...60 s	1...60 s
Signaldynamik, indgang / udgang	20 bit / 16 bit	19 bit / 16 bit	18 bit / 16 bit	22 bit / 16 bit	22 bit / 16 bit
Nøjagtighed	< ±0,05% af span	< ±0,1% af span	< ±0,05% af span	< ±0,05% af span	< ±0,05% af span
Temperaturkoefficient	< ±0,01% af span / °C	< ±0,01% af span / °C	< ±0,01% af span / °C	< ±0,005% af span / °C	< ±0,005% af span / °C
NAMUR	NE21, NE43	NE43	NE21, NE43	NE21, NE43, NE89	NE21, NE43, NE89
Kanaler	1 eller 2	1 eller 2	1 eller 2	1 eller 2	1 eller 2
Programmering	5909	5909	5909	5909/HART 5	5909/HART 7/HART 5
GODKENDELSER:					
ATEX	✓	✓	✓	✓	✓
IECEx	✓	✓	✓	✓	✓
FM	✓	✓	✓	✓	✓
CSA	✓	✓	✓	✓	✓
UL				✓	✓
DNV					
EAC Ex	✓	✓	✓	✓	✓
SIL Hardware Assessment				✓	✓
APPLIKATIONSGUIDE:					
RTD- / TC- / mV-indgang	✓/✓/✓	✓/✓/✓	✓/✓/✓	✓/✓/✓	✓/✓/✓
Lin. R / potentiometer-indgang	✓/✓	✓/✓	✓/✓	✓/✓	✓/✓
Dobbelt indgang (4 terminaler)	✓	✓	✓	✓	✓
Kundefineret følerlinearisering	✓	✓	✓	✓	✓
mA-udgang	✓	✓	✓	✓	✓
Loop-forsyning	✓	✓	✓	✓	✓
Galvanisk isoleret	✓	✓	✓	✓	✓
HART-protokol				✓	✓
Kalibrering af processignal	✓	✓	✓	✓	✓

EX-TEMPERATURTRANSMITTERE



TYPE

6437D

7501

INDGANG:
RTD, lineær modstand,
TC, mV, potentiometer

UDGANG:
mA,
HART-kommunikation

2-tråds HART 7
temperaturtransmitter

Feltmonteret
HART-temperatur-
transmitter

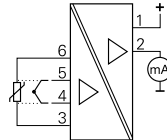
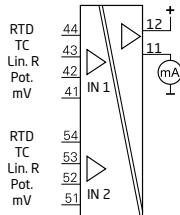

INDGANG:

mV, måleområde	± 800 mV, -0.1...+1.7 V	-800...+800 mV
mV, min. span	2,5 mV	2,5 mV
RTD, måleområde / min. span	-200...+850°C / 10°C	-200...+850°C / 10°C
Lin. R, måleområde / min. span	0...100 kΩ / 25 Ω	0...7000 Ω / 25 Ω
Potentiometer	10 Ω...100 kΩ / 10%	
Følerforbindelse, ledere	2 - 3 - 4	2 - 3 - 4
TC-typer	BEJKNRSTUW3W5Lr	BEJKNRSTUW3W5
Koldt loddestedskompensering	Intern / ekstern	Intern / ekstern

UDGANG:

mA, signalområde / min. span	3,5...23 mA / 16 mA	3,5...23 mA / 16 mA
------------------------------	---------------------	---------------------

TEKNISKE SPECIFIKATIONER:

Omgivelsestemperatur	-50...+85°C	-40...+85°C
Forsyningsspænding, DC	7,5...30 VDC	10 / 12...30 VDC
Max. forbrug, 1 / 2 kanaler	< 850 mW / -	
Isolationsspænding, test / drift	2,5 kVAC / 42 VAC	1500 VAC / 50 V
Reaktionstid	70 ms	22 bit / 16 bit
Signaldynamik, indgang / udgang	24 bit / 18 bit	1...60 s
Nøjagtighed	≤ ±0,05% af span	≤ ±0,05% af span
Temperaturkoefficient	< ±0,005% af span / °C	< ±0,005% af span / °C
NAMUR	NE21 / 43 / 44 / 89 / 107	NE21, NE43
Kanaler	1 eller 2*	1
Programmering	5909 / HART 7 / HART 5	LOI / HART

GODKENDELSER:

ATEX	✓	✓
IECEX	✓	✓
FM	✓	✓
CSA	✓	✓
INMETRO	✓	✓
EU-RO marine	✓	✓
EAC Ex	✓	✓
NEPSI	✓	✓
SIL Hardware Assessment	✓	✓
SIL 2/3 Full Assessment IEC 61508	✓ / ✓	

APPLIKATIONSGUIDE:

RTD- / TC- / mV-indgang	✓ / ✓ / ✓	✓ / ✓ / ✓
Lin. R / potentiometer-indgang	✓ / ✓	✓ / -
Dobbelt indgang (4 terminaler)		✓
Ægte dobbelt indgang (8 terminaler)	✓	
Kundedefineret følerlinearisering	✓	✓
mA-udgang	✓	✓
Loop-forsynet	✓	✓
Galvanisk isoleret	✓	✓
HART-protokol	✓	✓
Kalibrering af processignal	✓	✓

EX-BARRIERER



TYPE	9106B	9107B	9113B	9116B
------	-------	-------	-------	-------

INDGANG:

mA, mV, V, potentiometer, RTD, Lin. R, TC, HART-kommunikation

UDGANG:

mA, relæer, HART-kommunikation

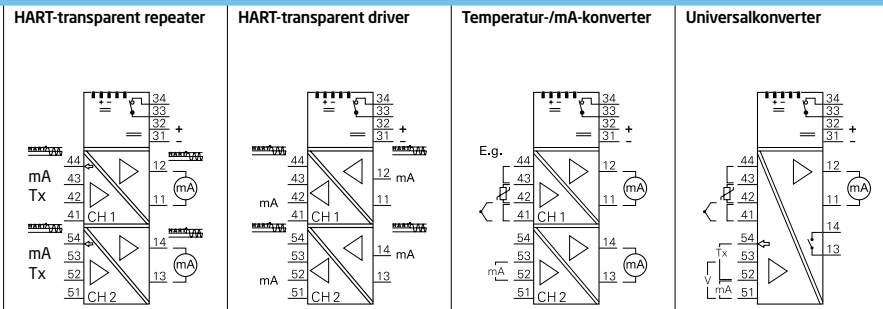

INDGANG:

mA, måleområde / min. span	3,5...23 mA / 16 mA	3,5...23 mA / 16 mA	0...23 mA / 16 mA	0...23 mA / 16 mA
V, måleområde / min. span				0...12 VDC / 0,8 V
RTD, måleområde / min. span			-200...+850°C / 25°C	-200...+850°C / 25°C
Lin. R, måleområde / min. span				0...10000 Ω / -
Potentiometer				10 Ω...10000 Ω
Følerforbindelse, ledere			2 - 3 - 4	2 - 3 - 4
TC-typer			BEJKNLRSTUW3W5Lr	BEJKNLRSTUW3W5Lr

UDGANG:

mA, signalområde / min. span	3,5...23 mA / 16 mA	3,5...23 mA / 16 mA	0...23 mA / 16 mA	0...23 mA / 16 mA
Relæ				1 x SPST, AC: 500 VA

TEKNISKE SPECIFIKATIONER:

Omgivelsestemperatur	-20...+60°C	-20...+60°C	-20...+60°C	-20...+60°C
Forsyningsspænding, DC	19,2...31,2 VDC	19,2...31,2 VDC	19,2...31,2 VDC	19,2...31,2 VDC
Max. forbrug, 1 / 2 kanaler	≤ 1,1 W / ≤ 1,9 W	≤ 1,0 W / ≤ 1,8 W	≤ 0,8 W / ≤ 1,4 W	≤ 2,1 W / -
Isolationsspænding, test / drift	2,6 kVAC / 250 VAC	2,6 kVAC / 250 VAC	2,6 kVAC / 250 VAC	2,6 kVAC / 250 VAC
Reaktionstid	< 5 ms	< 5 ms	0,4 / 1...60 s	0,4 / 1...60 s
Signaldynamik, indgang / udgang	Analog signaloverførsel	Analog signaloverførsel	24 bit / 16 bit	24 bit / 16 bit
Nøjagtighed	< ±16 µA	< ±16 µA	< ±0,1% af span	< ±0,1% af span
Temperaturkoefficient	< ±0,01% af span / °C	< ±0,01% af span / °C	< ±0,01% af span / °C	< ±0,01% af span / °C
NAMUR	NE21	NE21	NE21, NE43	NE21, NE43
Kanaler	1 eller 2	1 eller 2	1 eller 2	1
Programmering	Enheder i 4500-serien	Enheder i 4500-serien	Enheder i 4500-serien	Enheder i 4500-serien

GODKENDELSER:

ATEX	✓	✓	✓	✓
IECEx	✓	✓	✓	✓
FM	✓	✓	✓	✓
INMETRO	✓	✓	✓	✓
UL 61010 / 913	✓ / ✓	✓ / ✓	✓ / ✓	✓ / ✓
DNV	✓	✓	✓	✓
EAC Ex	✓	✓	✓	✓
SIL 2/3 Full Assessment IEC 61508	✓ / ✓	✓ / -	✓ / -	✓ / -
CCC	✓	✓	✓	✓
KCs	✓	✓	✓	✓

APPLIKATIONSGUIDE:

AI-barriere	✓		✓	✓
AO-barriere		✓		
DI-barriere				
DO-barriere				
mA- / V- / temperaturindgang	✓ / - / -	✓ / - / -	✓ / - / ✓	✓ / ✓ / ✓
4...20 mA transmitter-indgang	✓			✓
mA- / V- / relæudgang	✓ / - / -	✓ / - / -	✓ / - / -	✓ / - / ✓
Aktiv / passiv mA-udgang	✓ / ✓	✓ / -	✓ / ✓	✓ / ✓
HART-signal transparent	✓	✓		
Kalibrering af processignal			✓	✓
Forsyning via power rail	✓	✓	✓	✓



TYPE	9202B	9203B			
INDGANG: Hz	Impulsisolator	Ventil-/alarmdriver			
UDGANG: Impuls, relæ					
INDGANG: mA, måleområde / min. span V, måleområde / min. span RTD, måleområde / min. span Lin. R, måleområde / min. span Potentiometer Følerforbindelse, ledere TC-typer Følertype Hz, måleområde / min. span Min. impulsbredde					
UDGANG: mA, signalområde / min. span Impulsudgang Hz, signalområde Relæ					
TEKNISKE SPECIFIKATIONER: Omgivelsestemperatur Forsyningsspænding, DC Max. forbrug, 1 / 2 kanaler Isolationsspænding, test / drift Reaktionstid Signaldynamik, indgang / udgang Nøjagtighed Temperaturkoefficient NAMUR Kanaler Programmering					
GODKENDELSER: ATEX IECEX FM INMETRO UL 61010 / 913 DNV EAC Ex SIL 2/3 Full Assessment IEC 61508 CCC KCs					
APPLIKATIONSGUIDE: AI-barriere AO-barriere DI-barriere DO-barriere mA- / V- / temperaturindgang 4...20 mA transmitter-indgang mA- / V- / relæudgang Aktiv / passiv mA-udgang HART-signal transparent Kalibrering af processignal Forsyning via power rail					

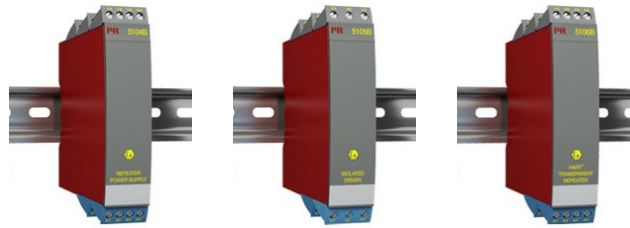

TYPE	5104B	5105B	5106B		
INDGANG: mA, mV, V, potentiometer, RTD, lineær modstand, TC, HART-transparent	Repeater/ spændingsforsyning	Ex-isoleret driver	HART-transparent repeater		
UDGANG: mA, V, relæer, HART-transparent					
INDGANG:					
mA, måleområde / min. span	0...23 mA / 16 mA	0...23 mA / 16 mA	3,5...23 mA / 16 mA		
V, måleområde / min. span	0...10 VDC / 8 VDC	0...10 VDC / 8 VDC			
mV, måleområde / min. span					
RTD, måleområde / min. span					
Lin. R, måleområde / min. span					
Potentiometer					
Følerforbindelse, ledere					
TC-typer					
Max. nulpunktsforskydning	20% af valgt max. værdi	20% af valgt max. værdi	20% af valgt max. værdi		
UDGANG:					
mA, signalområde / min. span	0...23 mA / 16 mA	0...23 mA / 16 mA	3,5...23 mA / 16 mA		
Belastning (v. strømudgang)	≤ 600 Ω	≤ 770 Ω	≤ 600 Ω		
V, signalområde / min. span	0...10 VDC / 0,8 VDC	0...10 VDC / 0,8 VDC			
Max. nulpunktsforskydning	20% af valgt max. værdi	20% af valgt max. værdi	20% af valgt max. værdi		
TEKNISKE SPECIFIKATIONER:					
Omgivelsestemperatur	-20...+60°C	-20...+60°C	-20...+60°C		
Forsyningsspænding, AC / DC	21,6...253 V / 19,2...300 V	21,6...253 V / 19,2...300 V	21,6...253 V / 19,2...300 V		
Max. forbrug, 1 / 2 kanaler	2,0 W / 2,8 W	1,3 W / 2,0 W	2,0 W / 2,8 W		
Isolationsspænding, test / drift	3,75 kVAC / 250 VAC	3,75 kVAC / 250 VAC	3,75 kVAC / 250 VAC		
Reaktionstid	< 25 ms	< 25 ms	< 25 ms		
Signaldynamik, indgang / udgang	Analog signaloverførsel	Analog signaloverførsel	Analog signaloverførsel		
Nøjagtighed	< ±0,1% af span	< ±0,1% af span	< ±0,1% af span		
Temperaturkoefficient	< ±0,01% af span / °C	< ±0,01% af span / °C	< ±0,01% af span / °C		
NAMUR	NE21	NE21	NE21		
Kanaler	1 eller 2	1 eller 2	1 eller 2		
Programmering	DIP-switch	DIP-switch	Nej		
GODKENDELSER:					
ATEX	✓	✓	✓		
IECEx					
FM					
CSA					
UL	✓	✓	✓		
DNV	✓	✓	✓		
EAC Ex	✓	✓	✓		
APPLIKATIONSGUIDE:					
AI-barriere	✓		✓		
AO-barriere		✓			
DI-barriere					
DO-barriere					
RTD- / TC-indgang					
mA- / V- / mV-indgang	✓ / ✓ / -	✓ / ✓ / -	✓ / - / -		
4...20 mA transmitter-indgang	✓		✓		
Lin. R / potentiometer-indgang					
mA- / V- / relæudgang	✓ / ✓ / -	✓ / ✓ / -	✓ / - / -		
Aktiv / passiv mA-udgang	✓ / ✓	✓ / -	✓ / ✓		
Kalibrering af processignal					

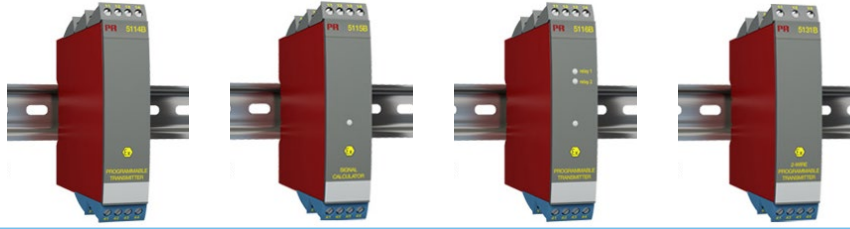

TYPE

5114B

5115B

5116B

5131B

INDGANG:

mA, mV, V, potentiometer, RTD, lineær modstand, TC

UDGANG:

mA, V, relæer,

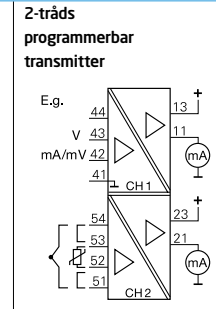
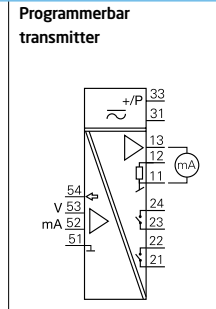
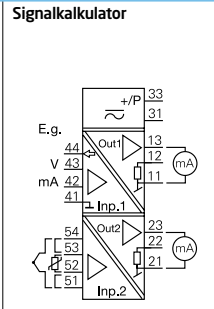
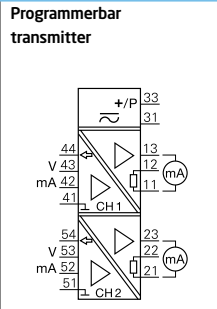

INDGANG:	5114B	5115B	5116B	5131B
mA, måleområde / min. span	0...100 mA / 4 mA	0...100 mA / 4 mA	0...100 mA / 4 mA	0...100 mA / 4 mA
V, måleområde / min. span	0...250 VDC / 5 mV	0...250 VDC / 5 mV	0...250 VDC / 5 mV	0...250 VDC / 5 mV
mV, måleområde / min. span	-150...+150 mV / 5 mV	-150...+150 mV / 5 mV	-2500...+2500 mV / 5 mV	-150...+150 mV / 5 mV
RTD, måleområde / min. span	-200...+850°C / 25°C	-200...+850°C / 25°C	-200...+850°C / 25°C	-200...+850°C / 25°C
Lin. R, måleområde / min. span	0...5000 Ω / 30 Ω	0...5000 Ω / 30 Ω	0...5000 Ω / 30 Ω	0...5000 Ω / 30 Ω
Potentiometer	200 Ω...100 kΩ	200 Ω...100 kΩ	200 Ω...100 kΩ	200 Ω...100 kΩ
Følerforbindelse, ledere	2 - 3 - 4	2 - 3 - 4	2 - 3 - 4	2 - 3 - 4
TC-typer	BEJ, KLN, RST, UW3W5Lr	BEJ, KLN, RST, UW3W5Lr	BEJ, KLN, RST, UW3W5Lr	BEJ, KLN, RST, UW3W5Lr
Max. nulpunktsforskydning	50% af valgt max. værdi	50% af valgt max. værdi	50% af valgt max. værdi	50% af valgt max. værdi
UDGANG:				
mA, signalområde / min. span	0...23 mA / 10 mA	0...23 mA / 10 mA	0...23 mA / 10 mA	3,5...23 mA / 10 mA
Belastning (v. strømudgang)	600 Ω	600 Ω	600 Ω	600 Ω
V, signalområde / min. span	0...10 VDC / 0,5 VDC	0...10 VDC / 0,5 VDC	0...10 VDC / 0,5 VDC	0...10 VDC / 0,5 VDC
Max. nulpunktsforskydning	50% af valgt max. værdi	50% af valgt max. værdi	50% af valgt max. værdi	50% af valgt max. værdi
Relæer			2 x SPST, AC: 500 VA	
TEKNISKE SPECIFIKATIONER:				
Omgivelsestemperatur	-20...+60°C	-20...+60°C	-20...+60°C	-20...+60°C
Forsyningsspænding, AC / DC	21,6...253 V / 19,2...300 V	21,6...253 V / 19,2...300 V	21,6...253 V / 19,2...300 V	- / 7,5...35 VDC
Max. forbrug, 1 / 2 kanaler	2,1 W / 2,8 W	2,1 W / 2,8 W	2,4 W / -	0,8 W / 1,6 W
Isolationsspænding, test / drift	3,75 kVAC / 250 VAC	3,75 kVAC / 250 VAC	3,75 kVAC / 250 VAC	3,75 kVAC / 250 VAC
Reaktionstid	250 ms...60 s	250 ms...60 s	250 ms...60 s	250 ms...60 s
Signaldynamik, indgang / udgang	22 bit / 16 bit	22 bit / 16 bit	22 bit / 16 bit	22 bit / 16 bit
Nøjagtighed	< ±0,05% af span	< ±0,05% af span	< ±0,05% af span	< ±0,05% af span
Temperaturkoefficient	< ±0,01% af span / °C	< ±0,01% af span / °C	< ±0,01% af span / °C	< ±0,01% af span / °C
NAMUR	NE21, NE43	NE21, NE43	NE21, NE43	NE21, NE43
Kanaler	1 eller 2	2	1	1 eller 2
Programmering	5909 + DIP-switch	5909 + DIP-switch	5909	5909 + DIP-switch

GODKENDELSER:	5114B	5115B	5116B	5131B
ATEX	✓	✓	✓	✓
IECEx				
FM				
CSA				
UL				
DNV	✓	✓	✓	✓
EAC Ex	✓	✓	✓	✓

APPLIKATIONSGUIDE:	5114B	5115B	5116B	5131B
AI-barriere	✓	✓	✓	✓
AO-barriere				
DI-barriere				
DO-barriere				
RTD- / TC-indgang	✓ / ✓	✓ / ✓	✓	✓
mA- / V- / mV-indgang	✓ / ✓ / ✓	✓ / ✓ / ✓	✓	✓
4...20 mA transmitter-indgang	✓	✓	✓	✓
Lin. R / potentiometer-indgang	✓ / ✓	✓ / ✓	✓ / ✓	✓ / - / -
mA- / V- / relæudgang	✓ / ✓ / -	✓ / ✓ / -	✓	✓
Aktiv / passiv mA-udgang	✓ / ✓	✓ / ✓	✓	✓
Kalibrering af processignal	✓	✓		

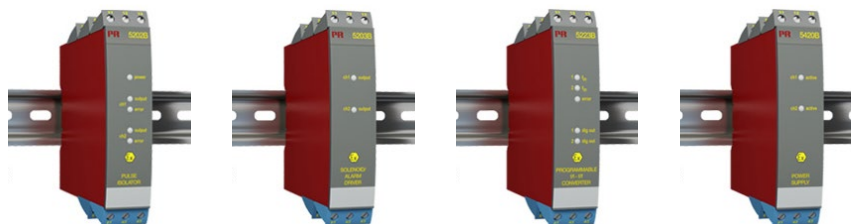

TYPE	5202B	5203B	5223B	5420B
	Impulsisolator	Ex ventil-/alarmdriver	Programmerbar f/I - f/f konverter	Ex-spændings-forsyning
INDGANG: Frekvens, impuls				
UDGANG: mA, V, impuls, relæer				

INDGANG:				
mA, måleområde / min. span				
V, måleområde / min. span				
mV, måleområde / min. span				
RTD, måleområde / min. span				
Lin. R, måleområde / min. span				
Potentiometer				
Følerforbindelse, ledere				
TC-typer				
Følertype	NAMUR / kontakt	NPN / PNP / kontakt	NAMUR / kontakt	
Hz, måleområde / min. span	0...5 kHz		0...20 kHz / 0,001 Hz	
UDGANG:				
mA, signalområde / min. span			0...23 mA / 5 mA	
V, signalområde / min. span			0...10 VDC / 0,25 VDC	
Impulsudgang	NPN / relæ	Valves etc.	NPN / PNP / relæ	
Hz, signalområde	0...5 kHz		0...1000 Hz	
Relæer	2 x SPDT, AC: 100 VA		2 x SPST, AC: 100 VA	1 x SPDT, AC: 100 VA
Spænding / strøm				> 18 VDC / 20 mA
TEKNISKE SPECIFIKATIONER:				
Omgivelsestemperatur	-20...+60°C	-20...+60°C	-20...+60°C	-20...+60°C
Forsyningsspænding, AC / DC	21,6...253 V/19,2...300 V	21,6...253 V/19,2...300 V	21,6...253 V/19,2...300 V	21,6...253 V/19,2...300 V
Max. forbrug, 1 / 2 kanaler	- / 1,8 W	2,0 W / 2,5 W	3 W / -	- / 2,5 W
Isolationsspænding, test / drift	3,75 kVAC / 250 VAC	3,75 kVAC / 250 VAC	3,75 kVAC / 250 VAC	3,75 kVAC / 250 VAC
Reaktionstid			60 ms...1000 s	
Signaldynamik, indgang / udgang			- / 16 bit	
Nøjagtighed				
Temperaturkoefficient			< ±0,01% af span / °C	
NAMUR	NE21	NE21		NE21
Kanaler	2	1 eller 2	1	2
Programmering	DIP-switch	DIP-switch	5909 + DIP-switch	Nej

GODKENDELSER:				
ATEX	✓	✓	✓	✓
IECEx				
FM				
CSA				
UL	✓	✓		
DNV				
EAC Ex	✓	✓	✓	✓
SIL 2, Hardware Assessment	✓			

APPLIKATIONSGUIDE:				
AI-barriere				
AO-barriere				
DI-barriere	✓		✓	
DO-barriere		✓		
mA- / V- / temperaturindgang				
4...20 mA transmitter-indgang				✓
mA- / V- / relæudgang				
Aktiv / passiv mA-udgang				
Kalibrering af processignal			✓	



TYPE	5531A	5531B1	5714	5715	5725
INDGANG: RTD, TC, mV, mA, V, potentiometer, frekvens, impuls UDGANG: Display, mA, relæer	4-cifret 4...20 mA LCD-instrument	Loop-forsynet LCD-instrument i Ex-indbygningskasse	Programmerbart LED-instrument	Programmerbart LED-instrument	Programmerbart frekvensinstrument
INDGANG:					
mA, måleområde / min. span	3,6...23 mA / 16 mA	3,6...23 mA / 16 mA	0...23 mA / 16 mA	0...23 mA / 16 mA	
V, måleområde / min. span			0...12 VDC / 0,8 V	0...12 VDC / 0,8 V	
Følertype					Alle standard følere \square
Hz, måleområde / min. span					0...50 kHz / 0,001 Hz
Min. impulsbredde					25 μ s
RTD, måleområde / min. span			-200...+850°C	-200...+850°C	
Lin. R, måleområde / min. span			0...10000 Ω / -	0...10000 Ω / -	
Potentiometer			10 Ω ...100 k Ω	10 Ω ...100 k Ω	
Følerforbindelse, ledere			2 - 3 - 4	2 - 3 - 4	
TC-typer			BEJKNRSTUW3W5Lr	BEJKNRSTUW3W5Lr	
Koldt loddetedskompensering			Intern	Intern	
Referencespænding / 2-trådsforsyning			- / >15 VDC	- / >15 VDC	
Følerforsyning					5...17 VDC
UDGANG:					
Display, ciffer / type	4-cifret / LCD	4-cifret / LCD	4-cifret / LED	4-cifret / LED	4-cifret / LED
Display, cifferhøjde	16 mm	16 mm	13,8 mm	13,8 mm	13,8 mm
mA, signalområde / min. span			0...23 mA / 16 mA	0...23 mA / 16 mA	0...23 mA / 16 mA
Relæ			2 x SPDT, AC: 500 VA	4 x SPDT, AC: 500 VA	2 x SPDT, AC: 500 VA
TEKNISKE SPECIFIKATIONER:					
Omgivelsestemperatur	-20...+60°C	-20...+60°C	-20...+60°C	-20...+60°C	-20...+60°C
Forsyningsspænding universel, AC / DC	- / 1,5 VDC	- / 1,5 VDC	21,6...253 V / 19,2...300 V	21,6...253 V / 19,2...300 V	21,6...253 V / 19,2...300 V
Max. forbrug	<35 mW	<35 mW	3,5 W	3,8 W	3,6 W
Isolationsspænding, test / drift			2,3 kVAC / 250 VAC	2,3 kVAC / 250 VAC	2,3 kVAC / 250 VAC
Reaktionstid	< 1 s	< 1 s	< 400 ms / < 1 s	< 400 ms / < 1 s	1...60 s
Nøjagtighed	< \pm 0,1% af span	< \pm 0,1% af span	< \pm 0,1% af visning	< \pm 0,1% af visning	< \pm 0,1% af visning
Temperaturkoefficient	< \pm 0,01% af span / °C	< \pm 0,01% af span / °C	< \pm 0,01% af visning / °C	< \pm 0,01% af visning / °C	< \pm 0,01% af visning / °C
NAMUR			NE43	NE43	NE43
Programmering	Switch / fronttaster	Switch / fronttaster	Fronttaster	5909 / fronttaster	Fronttaster
GODKENDELSER:					
ATEX, Zone 2	✓	✓			
UL 508			✓	✓	✓
DNV EU-RO marine			✓	✓	✓
EAC	✓	✓	✓	✓	✓

APPLIKATIONSGUIDE:	5531A	5531B1	5714	5715	5725
mA - / V - / mV-indgang	✓ / - / -	✓ / - / -	✓ / ✓ / -	✓ / ✓ / -	
Temperaturindgang			✓	✓	
Lin. R / potentiometer-indgang			✓ / ✓	✓ / ✓	
Frekvensindgang					✓
Kundedefineret følerlinearisering				✓	
4...20 mA transmitter-indgang			✓	✓	
Loop-forsynet	✓	✓			
mA-udgang			✓	✓	✓
2 / 4 relæudgange			✓ / -	- / ✓	✓ / -
Kalibrering af processignal	✓	✓	✓	✓	✓
Montering i Zone 2	✓	✓			



TYPE	5531B	5531B2			
INDGANG: mA	4-cifret 4...20 mA LCD-instrument	Loop-forsynet LCD-instrument i Ex-indbygningskasse			
UDGANG: Display					
INDGANG: mA, måleområde / min. span	3,6...23 mA / 16 mA	3,6...23 mA / 16 mA			
UDGANG: Display, ciffer / type Display, cifferhøjde	4-cifret / LCD 16 mm	4-cifret / LCD 16 mm			
TEKNISKE SPECIFIKATIONER: Omgivelsestemperatur Forsyningsspænding universel, AC / DC Max. forbrug Isolationsspænding, test / drift Reaktionstid Nøjagtighed Temperaturkoefficient NAMUR Programmering	-20...+60°C - / 1,5 VDC <35 mW Isolationsspænding, test / drift < 1 s < ±0,1% af span < ±0,01% af span / °C Switch / frontaster	-20...+60°C - / 1,5 VDC <35 mW Isolationsspænding, test / drift < 1 s < ±0,1% af span < ±0,01% af span / °C Switch / frontaster			
GODKENDELSER: ATEX DNV EAC Ex	✓ ✓ ✓	✓ ✓ ✓			
APPLIKATIONSGUIDE: Loop-forsynet Montering i Zone 1 / 21 Indbygningskasse	✓ ✓ ✓	✓ ✓ ✓			

SPÆNDINGSFORSYNINGER

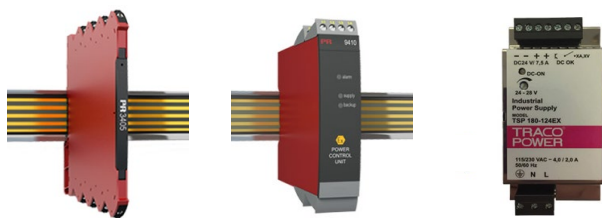

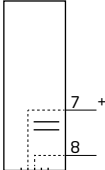
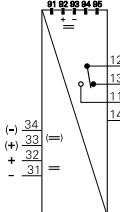
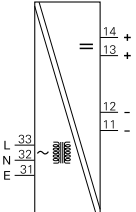
TYPE	3405	9410	9421		
INDGANG: AC-, DC-spænding UDGANG: Stabiliseret VDC	Power connector unit 	Power control unit 	Spændingsforsyning 		
INDGANG: Forsyningsspænding, AC			85...132 VAC eller 187...264 VAC		
Forsyningsspænding, DC	16,8...31,2 VDC	21,6...26,4 VDC			
Forsyningsspænding, back-up		21,6...26,4 VDC			
UDGANG: Spænding	16,8...31,2 VDC	21,6...26,4 VDC	24 VDC		
Strøm	2,5 ADC	4 ADC	4,8 ADC		
Effekt, max.	60 W	96 W	115 W		
Statusrelæ		1 x SPDT, AC: 500 VA			
TEKNISKE SPECIFIKATIONER: Omgivelsestemperatur	-25...+70°C	-20...+60°C	-20...+60°C		
Max. forbrug		96 W	< 135 W		
Isolationsspænding, test		2,6 kVAC	4,3 kVAC		
Kortslutningssikret	Nej	Ja	Ja		
Udgangsripple	Samme som indgang	Samme som indgang	200 mV peak / peak		
Kanaler	1	1	1		
Programmering	Nej	Nej	Nej		
GODKENDELSER: ATEX, Zone 2	✓	✓	✓		
IECEX, Zone 2	✓	✓			
UKEX, Zone 2	✓				
CSA, Zone 2 - DIV 2			✓		
FM, Zone 2 - DIV 2	✓	✓			
UL 61010 / 508 / 913	✓ / - / -	✓ / - / ✓	- / ✓ / - / -		
DNV	✓	✓			
EAC	✓	✓	✓		
INMETRO, Zone 2		✓			
CCC / KCs		✓ / ✓			
APPLIKATIONSGUIDE: 115 / 230 VAC netforsyning			✓		
24 VDC udgang			✓		
60 W power rail connector unit	✓				
96 W power rail connector unit		✓			
Power rail redundansfunktion		✓			
Kollektiv overvågning af statussignal		✓			
Intern sikring		✓	✓		
Montering i Zone 2 / DIV 2	✓	✓	✓		



TYPE	2224	2231	2261		
INDGANG, DC: mA, V, potentiometer, frekvens, impuls, joystick, vejecelle, mV	Ventilstyring	Grænsekontakt	mV-transmitter		
INPUT, AC: A, V					
UDGANG: mA, V, relæer					
INDGANG:					
mA, DC måleområde / min. span	0...20 mA / 16 mA	0...20 mA / 10 mA			
V, DC måleområde / min. span	-10...+10 VDC / 0,8 VDC	0...250 VDC / 0,5 VDC	-40...+100 mV / 10 mV		
A, AC måleområde / min. span		0...1 ARMS / 0,5 ARMS			
V, AC måleområde / min. span		0...250 VRMS / 0,5 VRMS			
Potentiometer	> 1 kΩ				
Digital indgang	3 x PNP		1 x NPN / 1 x PNP		
Max. nulpunktsforskydning	20% af valgt max. værdi		70% af valgt max. værdi		
Excitations- / referencespænding	- / -10...+10 VDC		5...13 VDC / -		
UDGANG:					
mA, signalområde / min. span	3000 mA		0...20 mA / 5 mA		
V, signalområde / min. span	Forsyning-0,5 VDC		0...10 VDC / 0,25 VDC		
Max. nulpunktsforskydning			50% af valgt max. værdi		
Relæer		2 x SPST, AC: 500 VA			
Display, cifret / type	3-cifret / LED	3-cifret / LED	3-cifret / LED		
TEKNISKE SPECIFIKATIONER:					
Omgivelsestemperatur	-20...+60°C	-20...+60°C	-20...+60°C		
Forsyningsspænding universel, AC / DC		21,6...253 V / 19,2...300 V			
Forsyningsspænding, DC	12 eller 24 VDC	19,2...28,8 VDC	19,2...28,8 VDC		
Max. forbrug	2,2 W	1,5 W DC / 2 W, UNI	2,2 W / max. 7,2 W		
Isolationsspænding, test / drift		3,75 kVAC / 250 VAC			
Reaktionstid	< 75 ms	250 ms...60 s	60 ms...999 s		
Signaldynamik, indgang / udgang	12 bit / -	16 bit / -	17 bit / 16 bit		
Setpunktsindstilling / gentagelse		0,1% / 0,1%			
Forsinkelse / hysteres		0...99,9 s / 0...99,9%			
Temperaturkoefficient	< ±0,01% af span / °C	< ±0,01% af span / °C	< ±0,01% af span / °C		
Kanaler	1 eller 2 udgange	1 indgang, 2 relæer	1		
Programmering	Switch / fronttaster	Switch / fronttaster	Switch / fronttaster		
GODKENDELSER:					
DNV		✓			
EAC	✓	✓	✓		
APPLIKATIONSGUIDE:					
mA- / V- / mV-indgang	✓ / ✓ / -	✓ / ✓ / -	- / - / ✓		
AC-signalindgang		✓			
Digital ON/OFF signalindgang	✓		✓		
Styrings- / reguleringsfunktion	✓	✓			
Vejecelle-applikationer			✓		
Proportionalventil-applikationer	✓				
Frekvens- / impulsapplikationer					
mA- / V-udgang			✓		
Relæudgang		✓			

En brugervenlig og pålidelig monteringsløsning mellem DCS-/PLC-/SIS-systemet og Ex-barrierer/signalisolatorer

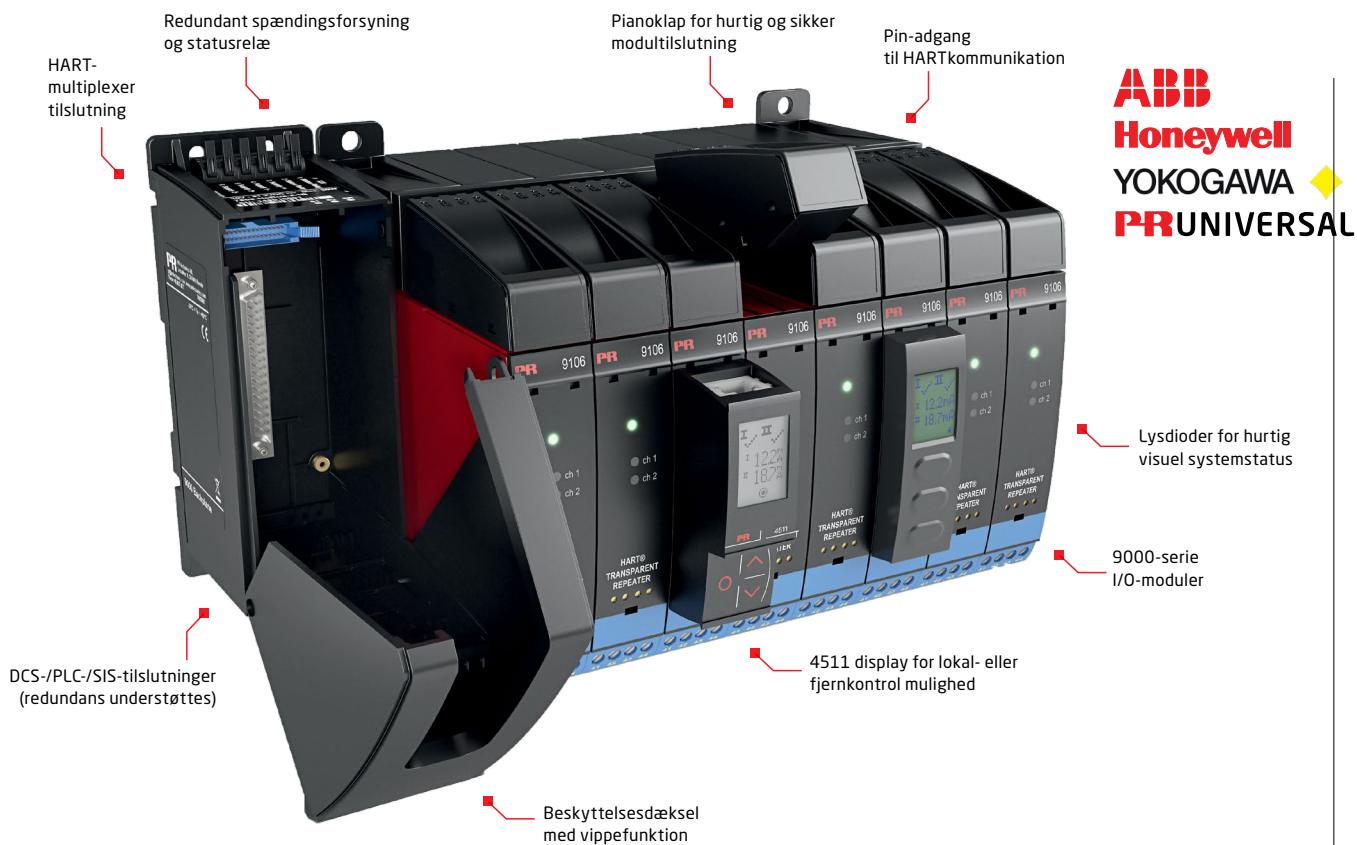

SIGNALTYPER

INDGANG

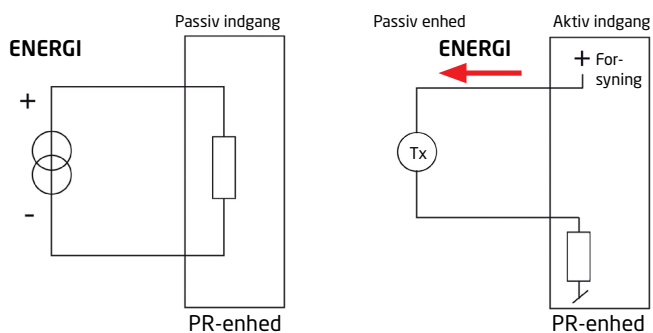

UDGANG

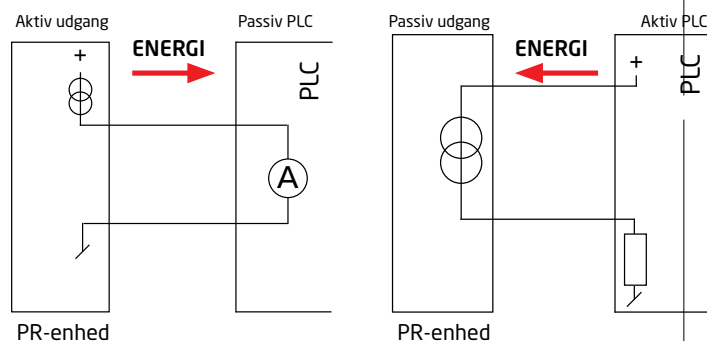

4510

Display- / programmeringsfront



4511

Modbus kommunikationsenhed



4512

Bluetooth kommunikationsenhed med datalogning



4590

ConfigMate



SOFTWARE

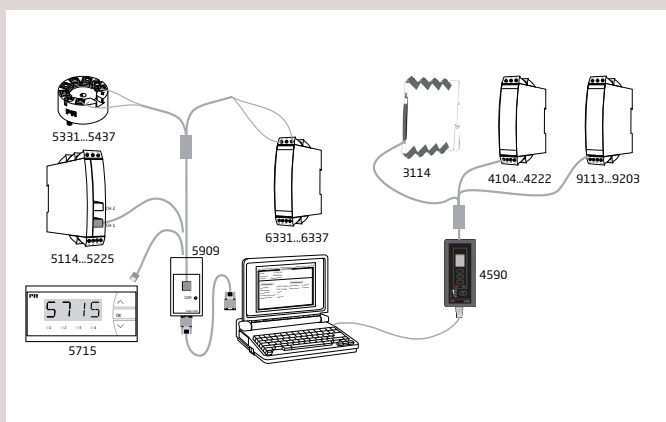

PRreset

PRreset er et brugervenligt, menu-styret softwareprogram til opsætning af PR-moduler via en standard-pc og et programmeringsinterface. PRreset giver stor fleksibilitet for hvert produkt, og når den ønskede opsætning er valgt, sendes data til modulet, som derefter er klar til brug.

Loop Link 5909

Loop Link 5909 er et USB-kommunikationsinterface til opsætning og monitorering af PR electronics' pc-programmerbare moduler. Loop Link 5909 kan benyttes til de PR-moduler, som findes i konfigurationsprogrammet PRreset ver. 5.0 eller højere.

277USB

HART-modem med USB-forbindelse



278

Bluetooth Low Energy (BLE) HART-modem



3400T

Elektromekanisk tæller, 6 cifre



5909

Loop Link kommunikationsinterface



5910

CJC-stik, kanal 1



5910EX

CJC-stik, kanal 1, Ex-version



5913

CJC-stik, kanal 2



5913EX

CJC-stik, kanal 2, Ex-version



7002

Holdebøjle



7005

Målemodstand 0,1 Ω



7006

Målemodstand 1,0 Ω



7007

2-cifret digitalpotentiometer, 10 k Ω



7008

3-cifret digitalpotentiometer, 10 k Ω



7009

10-turns potentiometer, 200 Ω



7010

10-turns potentiometer, 20 k Ω



7011

Dial for 10-turns potentiometer



7012

1-turn potentiometer, 1 k Ω

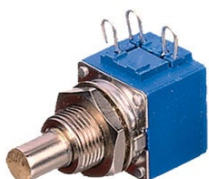

7014

Målemodstand 0,5 Ω



7015

1-turn potentiometer, 10 k Ω

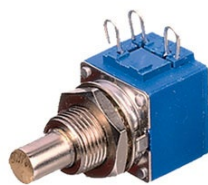

7016

1-turn potentiometer, 100 k Ω

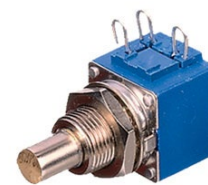

7020

Sort knap med rød top



7020A

Sort knap med rød top



7023

11-polet sokkel, sort

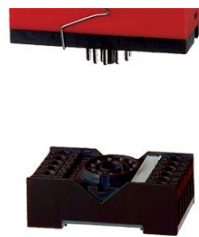

7024

Kodering og kodestift

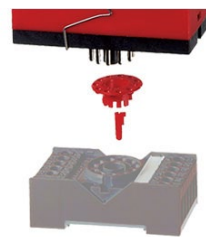

7028

10-turns potentiometer, 2 kΩ



7029

Målemodstand 0,2 Ω



7030

Målemodstand 0,1 Ω



7031

Labelark med ingeniørenheder



7400

Pt100 føler, ½" RG, klasse A



7410C

Pt100 rumføler, klasse A målesats Ø 6 x 79 mm



7423

Keramiksocket for Pt100 følere
3 terminaler



7430B

Pt100 kabelføler, Ø 6 x 60 mm



7430C

Pt100 kabelføler, Ø 5 x 20 mm



7440

Lomme f/ 7400 Pt100-føler



8335

Stænkæt afdækning



8341

Induktiv aftaster, NAMUR-type



8342

Induktiv aftaster, NAMUR-type



8343

Induktiv aftaster, NPN-type



8344

Induktiv aftaster, NPN-type



8421

DIN-skinnebeslag

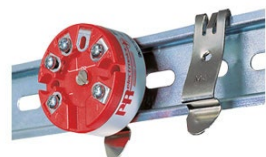

8501

Monteringskasse til PR-display



8509

M12-interfacekabel til 5909 Loop Link



8510

Modbuskabel



8511

4511 Y-splitter Modbus-kabel



8513

RJ45 Modbus terminering



8514

3 x RJ45 hun Y-splitter



8515

RJ45 hun til hun kabeladapter



8516

RJ45 hun til hun skærmet kabeladapter



8517

3 x RJ45 skærmet hun Y-splitter



8550

7501 M20-prop med silikone O-ring til alu-hus



8550-F

7501 M20-prop med FKM O-ring til alu-hus



8550-S

7501 M20-prop med silikone O-ring til rustfrit stål-hus



8550-SF

7501 M20-prop med FKM O-ring til rustfrit stål-hus



8551

7501 1/2NPT-prop til alu-hus



8551-S

7501 1/2NPT-prop til rustfrit stål-hus



8552

Rørmonteringsbeslag til 7501



8555

Display med LOI til 7501



8556

Display uden LOI til 7501



8557

Beslagreservedel til display og transmitter (til 7501)



8558

Beslagreservedel kun til transmitter (til 7501)



9400_1

Power rail 15 mm profil

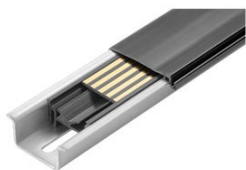

9400_2

Power rail 7,5 mm profil



9402

Ekstra endestop til power rail



9404

Modulstop



POWER RAIL

Databladet angiver det maksimale effektbehov ved nominelle driftsværdier, f.eks. 24 V forsyningspænding, 60°C omgivelsestemperatur, 600 Ω belastning og 20 mA udgangsstrøm.

I typiske applikationer arbejder enhederne ofte ikke under de værste tænkelige betingelser, specielt når mange enheder er placeret sammen. Derfor regnes der ofte med 70% af det maksimale effektbehov (P70%).

3000 power rail

Antallet* af 3000-enheder, der kan forsynes fra forskellige strømkilder, er angivet i nedenstående tabel:

	Forsyning via en PR-konverterenhed	Forsyning via 3405	Forsyning via 9410
P70%	Op til 21 enheder	Op til 131 enheder	Op til 210 enheder
P100%	Op til 14 enheder	Op til 92 enheder	Op til 147 enheder

Enhederne kan monteres vertikalt eller horisontalt uden indbyrdes afstand.

* Antallet af enheder er baseret på PR 3103, som har det laveste strømforbrug af de power rail-monterede enheder i 3000-serien.

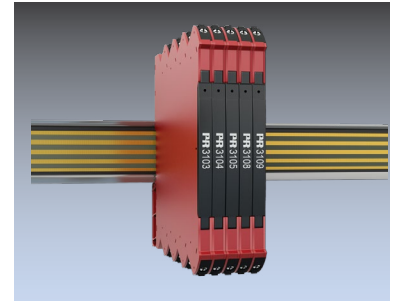

9000 power rail

Antallet af 9000-enheder, der kan forsynes fra 9400-strømkilder, er angivet i nedenstående skema:

	Forsyning via 9410
P70%	Op til 150 enheder
P100%	Op til 120 enheder



OMGIVELSESSPECIFIKATIONER

	PR serie 2200	PR serie 3000	PR serie 4000	PR serie 5000	PR serie 5300
Specifikationsområde	-20°C til +60°C	-25°C til +70°C (3105: 0°C til +70°C)	-20°C til +60°C	-20°C til +60°C	-40°C til +85°C
Relativ fugtighed	< 95% RF (ikke-kond.)	< 95% RF (ikke-kond.)	< 95% RF (ikke-kond.)	< 95% RF (ikke-kond.)	< 95% RF (ikke-kond.)
Kapslingsklasse	IP50	IP20	IP20	IP20	IP68 / IP00
	PR serie 5400	PR serie 5500 / 5700	PR serie 6300	PR serie 7500	PR serie 9000
Specifikationsområde	-50°C til +85°C	-20°C til +60°C	-40°C til +85°C	-20 / -40°C til +85°C	-20°C til +60°C
Relativ fugtighed	< 99% RH (ikke-kond.)	< 95% RF (ikke-kond.)	< 95% RF (ikke-kond.)	0...100% RF (kond.)	< 95% RF (ikke-kond.)
Kapslingsklasse	IP68 / IP00	IP65 fra front (5500) IP65 / type 4X, UL50E	IP20	IP54 / IP66 / IP68 / type 4X	IP20

KABINETSPECIFIKATIONER

Mål (mm)	Højde	Bredde	Dybde	Udskæringsmål	Materiale
PR serie 2200	80,5	35,5	84,5+sokkel		Cycology/Noryl
PR serie 3000	113	6,1	115		Cycology
PR serie 4000 / 6000 / 9000	109	23,5	104		Cycology
PR serie 4500	73,2	23,3	26,5		Cycology
PR serie 5000	109	23,5	130		Cycology
PR serie 5300	20,2	Ø44			Cycology
PR serie 5400	21,45	Ø44			Cycology
PR serie 5500 / 5700	48	96	120	44,5 x 91,5	Noryl
PR serie 7500	109	145	125,5		Aluminium

Få allerede i dag fordel af *PERFORMANCE MADE SMARTER*

PR electronics er den førende teknologivirksomhed med speciale i at gøre styringen af industriprocesser mere sikker, pålidelig og effektiv. Vi har siden 1974 udviklet en række kernekompetencer inden for innovativ højpræcisionsteknologi med lavt energiforbrug. Vi er kendt for fortsat at sætte nye standarder for produkter, som kommunikerer, monitorerer og forbinder vores kunders procesmålepunkter med deres processtyresystemer.

Vores innovative, patenterede teknologier er blevet til i kraft af vores omfattende R&D-faciliteter samt gennem et indgående kendskab til vores kunders behov og processer. Vores grundlæggende principper omhandler enkelhed, fokus, mod og dygtighed, hvilket sikrer, at nogle af verdens største virksomheder kan opnå PERFORMANCE MADE SMARTER.

1015DK-W21 (2323)

